



KTC-3 KTC-4

Revolving Door
Comfortline



Contemporary entrance applications – DORMA Comfortline revolving doors

Wherever central entrances of buildings have to handle heavy traffic volumes, where ease of use is paramount and where architecturally refined façades require an equally attractive complement, the DORMA Comfortline range of revolving doors provides the perfect application.

Superb user convenience

KTC revolving doors are characterised by their especially generous diameters – ranging from 3,600 to 6,200 mm. The automatic program modes can be selected in accordance with different usage requirements. This ensures optimum ease of use with access effectively aligned also to the requirements of the disabled. Even

the high traffic volumes that can occur in peak periods are handled by these doors without difficulty. In addition, the pivot-mounted wings will fold out in any position to provide a clear escape route.

Optimum cost efficiency

KTC revolving doors protect the building interior reliably against draughts, noise and dirt. The overall concept and the sophisticated detail applications of the KTC program range contribute to the optimisation of the building energy balance. Modern safety and security aspects have been taken fully into

account. Various night shields are also available as an option.

Flexible applications with respect to design

The design versatility and variability of the KTC range provides for enormous architectural scope. Co-ordinated materials and surface finishes enable the door to be harmonised with virtually any façade concept. The centre axle of the 3- and 4-wing revolving doors can also be utilised as a showcase. This means that, right at the entrance of the building, an attractive display can be provided as the first thing visitors see.

Data and features	DORMA KTC-4	DORMA KTC-3
Internal diameter in mm (D)	3600, 4200, 4800, 5400, 6200	3600, 4200, 4800, 5400, 6000
External diameter in mm (B)	3828, 4428, 5028, 5628, 6428	3828, 4428, 5028, 5628, 6228
Clear passage width in mm (LW) Clear escape route width in mm	(see pages 6/7)	(see pages 6/7)
Clear passage height in mm (LH) *	up to 4800 ø: 2200-2500; from 5400 ø: 2200	up to 4800 ø: 2200-2500; from 5400 ø: 2200
Canopy height in mm *	410-700	410-700
Total height in mm (H) *	up to 3200	up to 3200
Drum walls glazed	○	○
Drum walls with metal panelling	○	○
Suitable for application in emergency exits and escape routes	●	●
Floor ring	●	●
Floor mat	○	○
6 or 8 downlights	8 downlights	6 downlights
Preparation for rainproof roof	○	○
German type approval according to DIN 18650	○	○
Equipment according to DIN 18650	○	○
Manufactured to ISO 9001	●	●

● Yes ○ Option

* other sizes on request (Page 6)

Traffic capacities				
	Theoretical capacity ¹⁾	Practical capacity ²⁾		Maximum capacity ³⁾
Internal diameter (D) in mm	Persons/hour →	→ Persons/hour	↔	Persons/min. →
KTC-4				
3600	2592	864	1728	43
4200	3312	1104	2208	55
4800	3840	1280	2560	64
5400	4320	1440	2880	72
6200	5208	1736	3472	86
KTC-3				
3600	2916	972	1944	48
4200	3312	1104	2208	55
4800	4320	1440	2880	72
5400	4536	1512	3024	75
6000	5184	1728	3456	86

¹⁾ The theoretical capacity value indicates how many people can pass through the revolving door in one (→) direction per hour, assuming that the traffic flow is uniform and the internal segments are fully occupied.

²⁾ The practical capacity values indicate how many people can actually pass through the revolving door in one (→) and in both (↔) directions.

³⁾ The maximum capacity value indicates how many people can pass through the revolving door in one direction (→) per minute when there is a constant stream of traffic, for example in the morning and evening.

Benefits – point by point

... for the installer

- Comprehensive range that also includes applications suitable for sophisticated and prestigious entrances.

- Trouble-free installation and commissioning.

- Guaranteed advanced technology conforming to all relevant national and international standards.

... for the architect/specifier

- The sheer range of KTC system components ensures a high degree of design flexibility.

- Problem-free adaptability to individual requirements.

- Visually, technically and economically convincing application.

... for the user

- Exceptional convenience.

- Outstanding safety features.

- Tailored integrated application of industrial engineering precision and assured manufacturing quality.

- Optimisation of building energy balance and workplace environment.

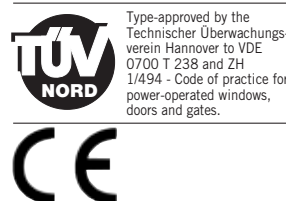

Designs, functions, standard equipment, optional extras

Models

Canopy-integrated operator

Turnstile, KTC-3

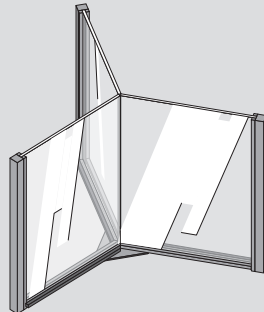

Without showcase (version 0)

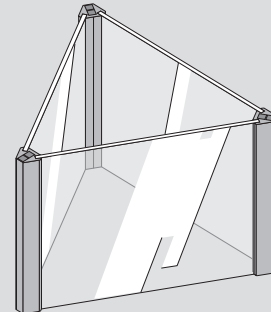

With straight showcase glazing (version 2)

Automatic

I: Door starts and stops automatically.
II: Door rotates continuously at low speed, which is increased as soon as a user approaches the door.

Speed limiter

decreases the speed to approx. 2 rpm (see page 11), for example for senior citizens and the disabled

KTC-3/0

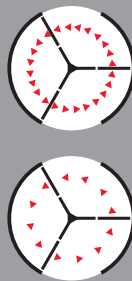

KTC-3/2

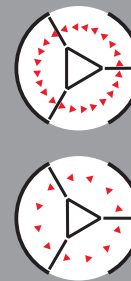

Configurations

Summer configuration

Also ideal for the passage of bulky items or luggage, and for consignment deliveries

Emergency escape configuration

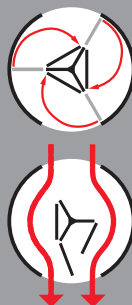

Options

Manually or electrically lockable wings



Movable night shields, internal



Movable night shields, external



Turnstile, KTC-4

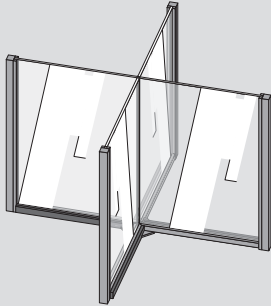

Without showcase (version 0)

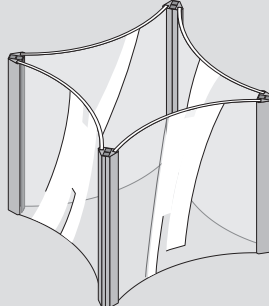

With curved showcase glazing (version 1)

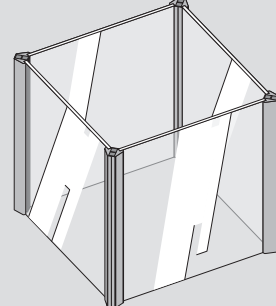

With straight showcase glazing (version 2)

KTC-4/0

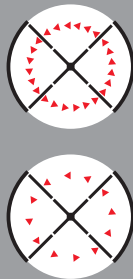

KTC-4/1

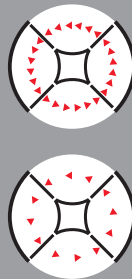

KTC-4/2

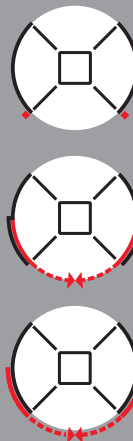
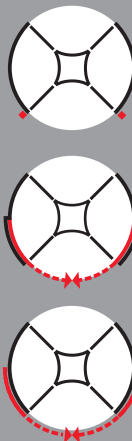
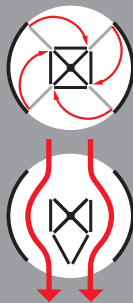

Four-wing design

DORMA KTC-4 Comfortline revolving doors are available in 5 standard sizes.

The 4-wing revolving doors are available in different versions. The pivot-mounted wings are equipped with horsehair brushes in order to ensure the reliable exclusion of draughts in the entrance area.

Turnstile versions

- Without showcase
- With straight showcase glazing
- With curved showcase glazing

Drum wall versions

- Without night shield
- With manually operated external night shield
- With manually or electrically operated internal night shield

Dimensions, KTC-4

Internal diameter (D)	3600	4200	4800	5400	6200
External diameter (B1)	3692	4292	4892	5492	6292
External diameter (B2)	3828	4428	5028	5628	6428
Clear passage width (LW)	2466	2891	3315	3740	4305
Escape route width	896	1066	1236	1406	1633
Clear passage height (LH)	up to 2500*		up to 2200*		
Total height (H)	up to 3200*		up to 2900*		
Canopy height (SH)	410 to 700*				

All dimensions in mm * Other heights on demand

Plan view, KTC-4

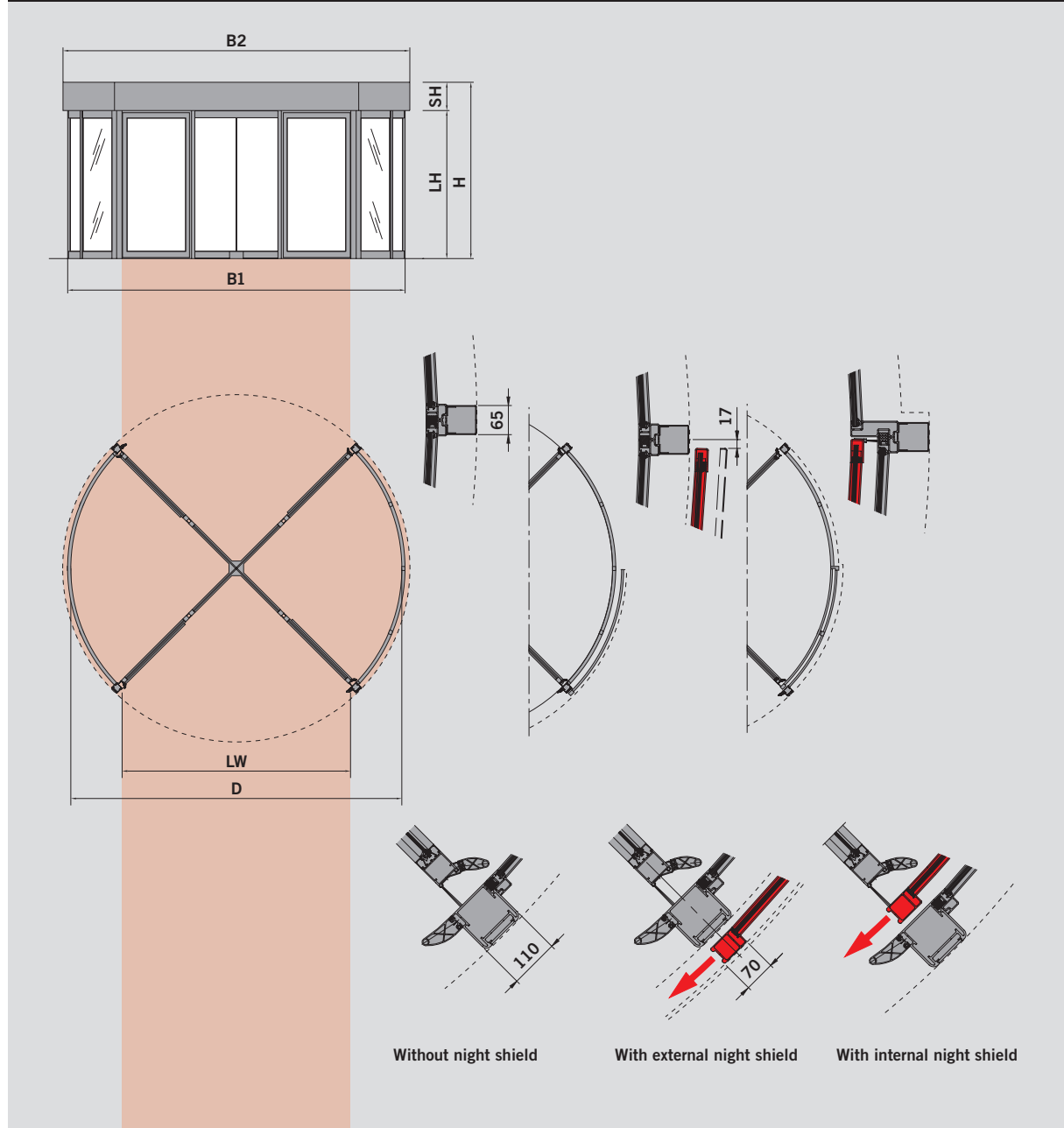

Three-wing design

DORMA KTC-3 Comfortline revolving doors are available in 5 standard sizes.

The 3-wing revolving doors are available in different versions. The pivot-mounted wings are equipped with horsehair brushes in order to ensure the reliable exclusion of draughts in the entrance area.

Central part versions

- Without showcase
- With straight showcase glazing

Drum wall versions

- Without night shield
- With manually operated external night shield
- With manually or electrically operated internal night shield

Dimensions, KTC-3

Internal diameter (D)	3600	4200	4800	5400	6000
External diameter (B1)	3692	4292	4892	5492	6092
External diameter (B2)	3828	4428	5028	5628	6228
Clear passage width (LW)	1645	1945	2245	2545	2845
Escape route width	986	1186	1386	1586	1786
Clear passage height (LH)	up to 2500*			up to 2200*	
Total height (H)	up to 3200*			up to 2900*	
Canopy height (SH)	410 to 700*				

All dimensions in mm. * Other heights on demand

Plan view, KTC-3

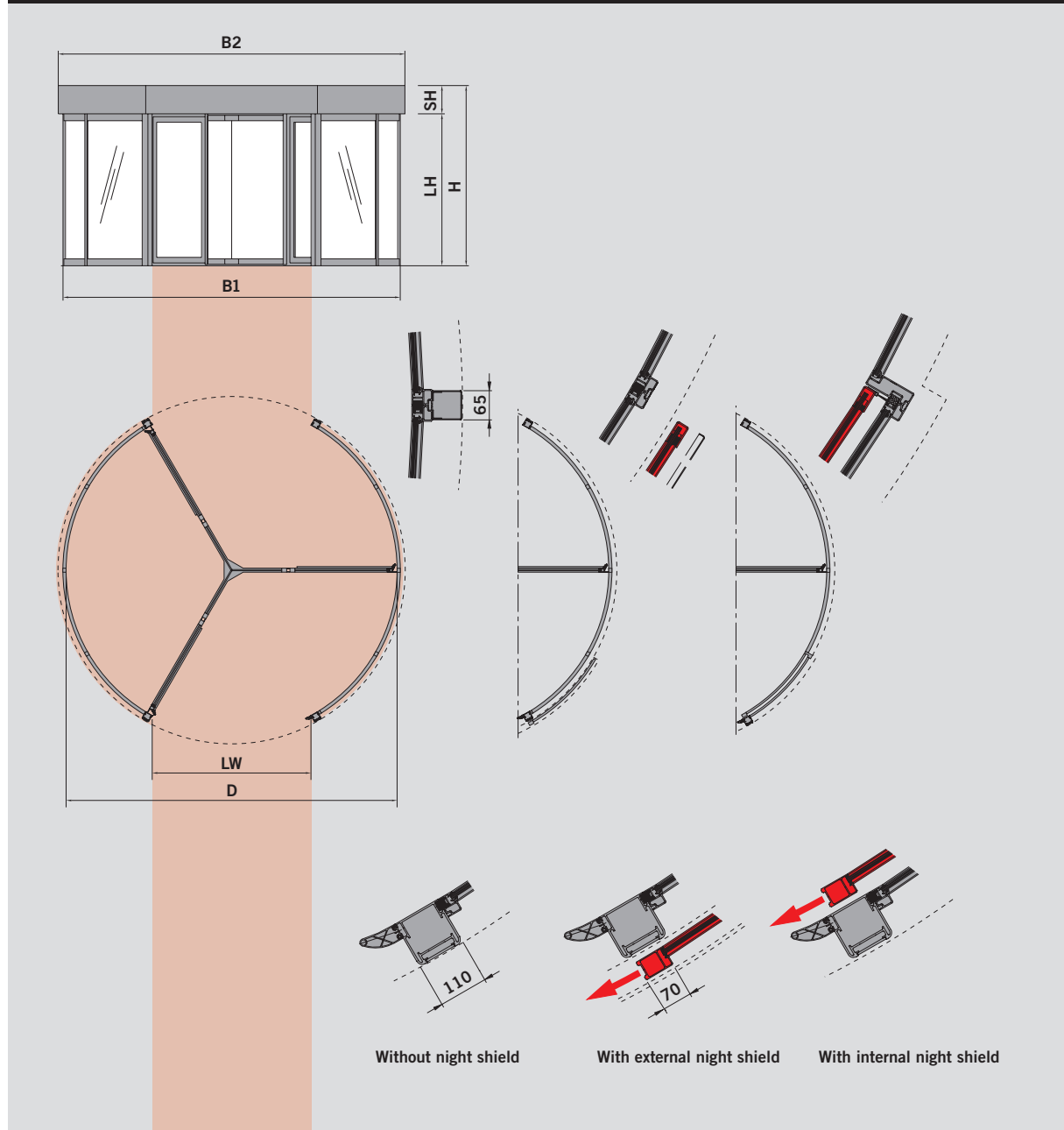

The perfect application for high user convenience

Aside from a range of dimensions, the KTC series also offers numerous application-aligned versions to suit individual requirements.

- KTC-3/0: Version with 3 wings and turnstile
- KTC-3/2: Version with 3 wings and central showcase with straight glass panes

- KTC-4/0: Version with 4 wings and turnstile
- KTC-4/1: Version with 4 wings and central showcase with curved glass panes
- KTC-4/2: Version with 4 wings and central showcase with straight glass panes

- Glazed drum walls or with optional metal panelling
- Additional manual or electrically operated night shields as optional extras.

Vertical sections

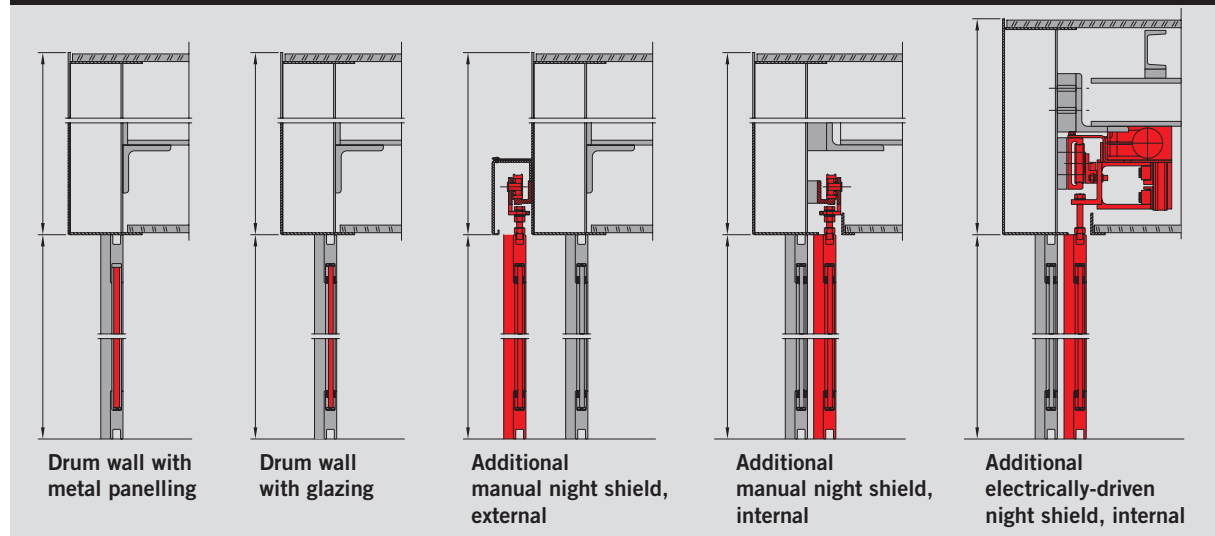

Vertical section

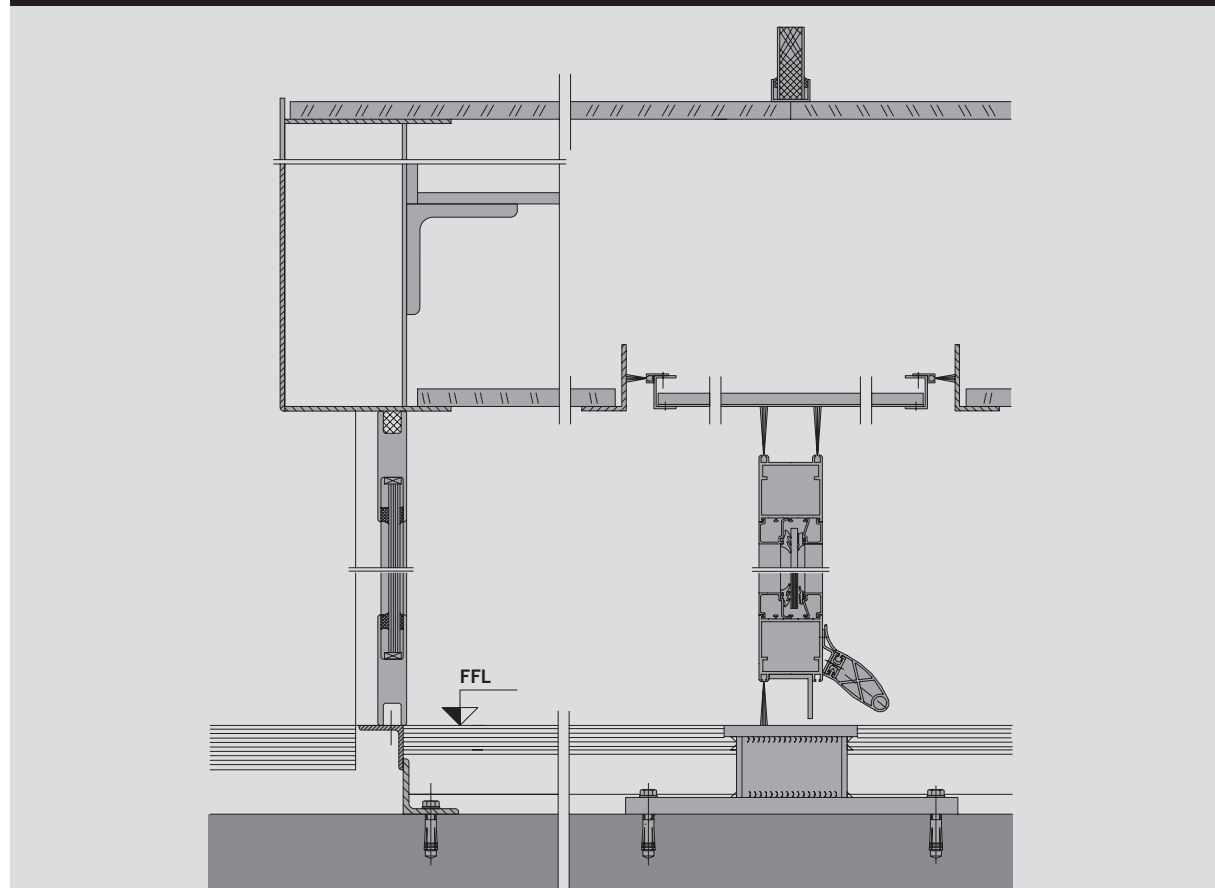

Floor rings

Installation size, diameter in mm	3600	4200	4800	5400	(6000 ¹⁾)	(6200 ²⁾)
Untreated floor to FFL (A) in mm	70-250					
Nominal radius (R) in mm	1800	2100	2400	2700	3000	3100
Floor mat (C) in mm	up to 30					

¹⁾ KTC-3 only

²⁾ KTC-4 only

Floor ring, KTC-3/KTC-4

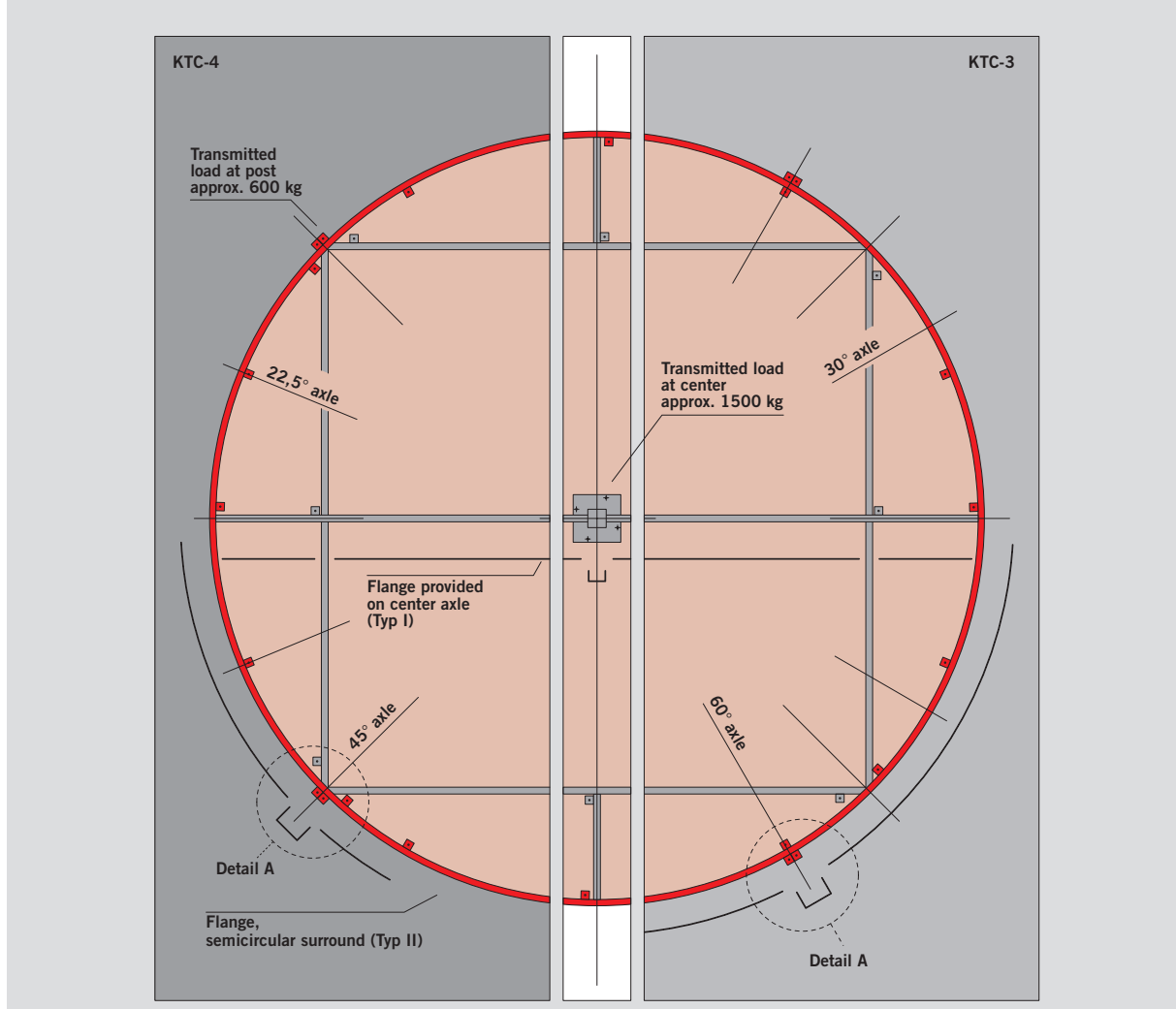

Detail A

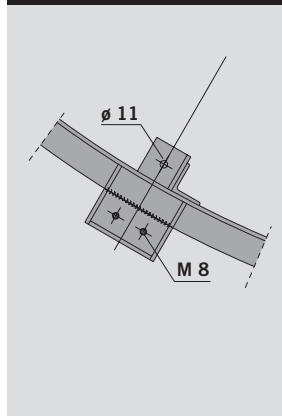

Cross sections

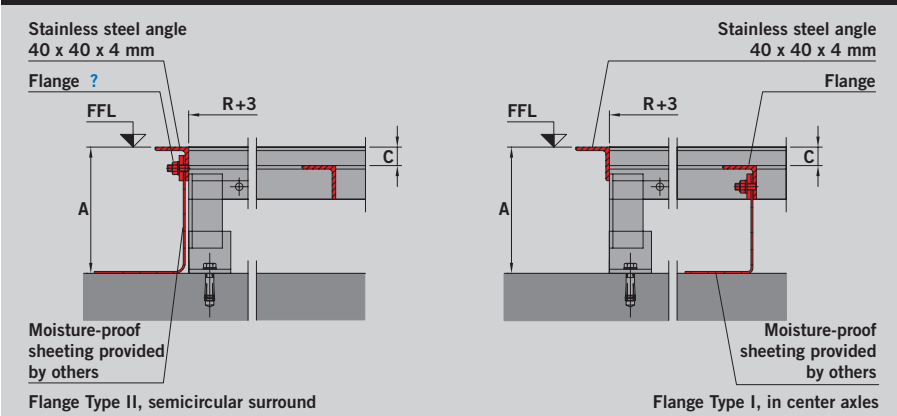

Safety equipment

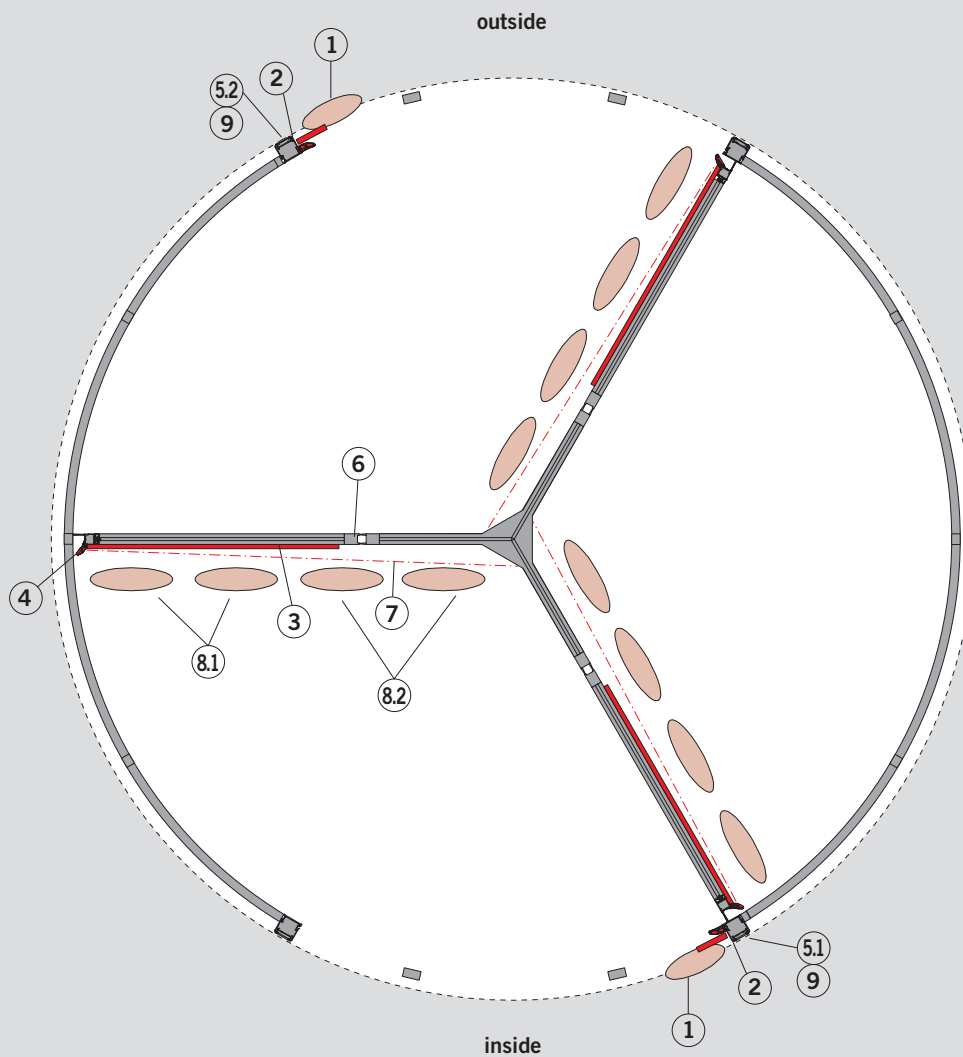
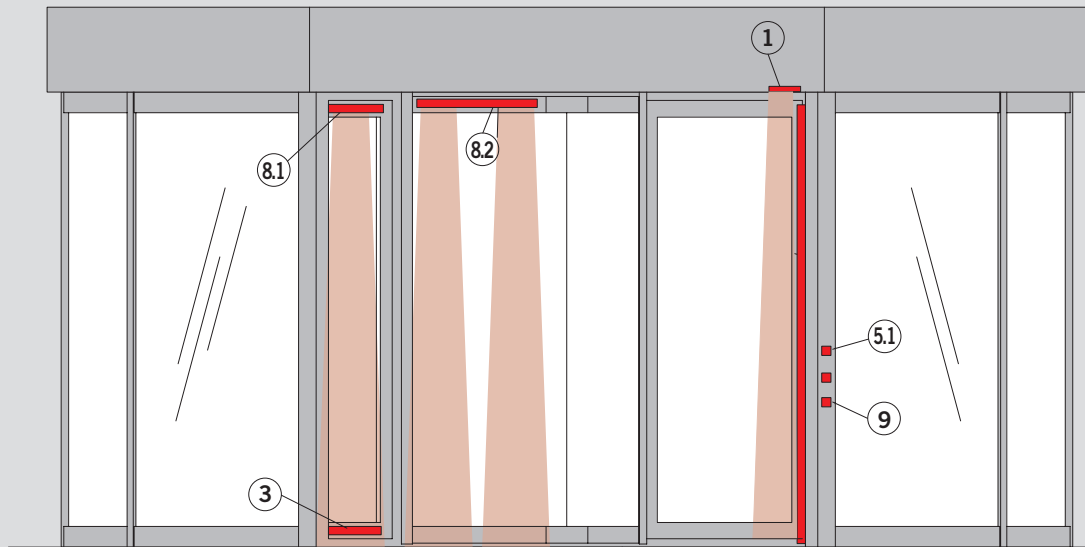

DORMA KTC-3/KTC-4 revolving doors offer a comprehensive range of safety equipment to ensure optimum protection of people and objects. The main closing edges are each equipped with two infrared safety sensors and a safety contact strip. As a wing arrives at a point 500 mm from the upright post at the end of the drum wall, the

infrared safety sensors and the contact strips on the post are activated. The outer edges and the bottom edges of the wings are likewise protected by safety contact strips. In addition, the wings fold on contact. As an optional extra, sensors can be provided on the top wing profile to protect the space in front of the wing.

Please note:

The safety equipment has to be selected according to the prevailing national requirements.

Doors according to DIN 18650 require all safety components that are mentioned below.

	Function
① Canopy sensors, (door post, top/canopy)	Cycle at low (creep) speed/stop
② Safety contact strip (door post)	Stop
③ Safety contact strip (wing, bottom)	Stop
④ Safety contact strip (wing, outside)	Stop
⑤ Emergency pushbutton (door post, inside)	Stop
⑥ Emergency pushbutton (door post, outside)	Stop
⑦ Limit switch for deflection device (pivot-mounted wing)	Stop
⑧ Light barrier (wing, bottom)	Stop
⑨ Top sensor (pivot-mounted wing, top)	Cycle at low (creep) speed/stop
⑩ Top sensor (rigid wing, top)	Cycle at low (creep) speed/stop
⑪ Disabled access pushbutton (post)	Cycle at low (creep) speed

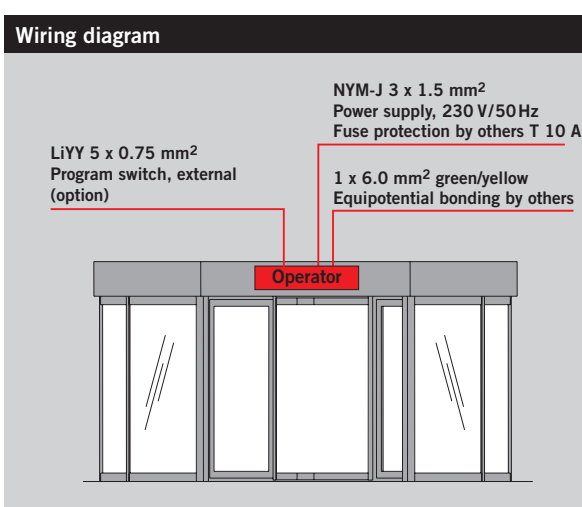

Automatic programs / Speed limiter

- Two different Automatic functions can be selected:
 - “Automatic I”** – The door is in starting position and activated as soon as a user approaches. Following an adjustable time, it stops again at its starting position.
 - “Automatic II”** – The door rotates continuously at approx. 1 rpm. As a user enters the detection range, the speed is increased to approx. 3 rpm. Following an adjustable period of time, the speed of the door is reduced again.
- The speed limiter is activated by means of a special pushbutton to reduce the speed of the door during passage to approx. 2 rpm.

External emergency pushbutton (Option)

Designation	Specification	Art.-No.
TL-N S55	NO contact: 1, NC contact: 1, maximum load current: 1 A at 24 V DC, flush-mounting, 80 x 80 mm, System 55	56330500
NAT 1	NO contact: 1, NC contact: 1, white frame, for flush-mounting, 80 x 80 mm, System 55	90400025
NAT 4	NO contact: 1, NC contact: 1, for surface-mounting, 68 x 68 mm	05027031332

Active infrared safety sensor

Designation	Specification	Art.-No.
IRIS ON	Black	16588801170
4SAFE	Active infrared sensor with background evaluation	
IRS-2		165217xx150
IRS-4		294xxx

Radar motion detector (Option)

Designation	Specification	Art.-No.
Prosecure Easy Motion Mono	Standard	8600X000
Prosecure Easy Motion Stereo	Richtungserkennung, schwarz	8601X000



www.dorma.com

WN 051 761 51532, 11/11, KTC-3/KTC-4, GB, x. XX. xx/11 Subject to change without notice

DORMA GmbH + Co. KG
DORMA Platz 1
D-58256 Ennepetal
Phone +49 2333 793-0
Fax +49 2333 793-4950