

Pure

Lever Handle Range

For timber doors



Pure 8100



Pure 3020

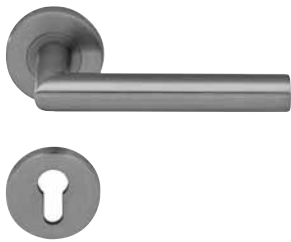

Pure 8906



Pure 8998

For narrow stile doors



Pure 8100



Pure 3548 V



Pure 8100 V



Pure 8906



DORMA Pure. Lever handle sets for standard applications on timber and narrow stile doors

Sophisticated design and functional quality are the characteristics of the DORMA Pure range. The fittings excel in terms of both their technology and operating reliability. Manufactured from high-grade materials and carefully crafted, DORMA Pure door furniture satisfies exacting demands with respect to stability, safety and corrosion resistance. The Pure range includes the most popular models, all of which are right or left sprung in order to return the lever handle to the horizontal position.

Lever handle furniture from the Pure range offers high quality at an attractive price. The hardware comes as complete sets for timber doors or as half sets for narrow stile doors. The Pure range is suitable for standard national and international applications, e.g. in the private homes segment or on interior doors in office buildings.

5

**YEARS WARRANTY
ON ALL PRODUCTS
FEATURING PURE
TECHNOLOGY***

Pure data and features		Timber doors	Narrow stile doors
Spring assisted		●	●
Securely bushed		●	●
EN 1906 category of use		3	3
Tested to EN 1634-1 ¹⁾		●	●
5 years warranty*		●	●
Steel mountings		●	●
Steel mountings with support lugs		●	–
Door thicknesses in mm		38 – 56	
Same screw length for full thickness range		●	
Back-to-back fixing		●	–
Square section spindle for lever handle		8 mm	8 mm
Lock type preparation	PZ (Europrofile cylinder)	●	●
	BB (warded lever)	●	–
	UN (Latchplate)	●	●
Sets	Standard sets	●	●
	Entrance sets	●	●
	WC sets	●	–
Material	Stainless steel, satin	●	●
	Aluminium F1 silver anodised	●	●

● standard – no

¹⁾ When used with fire and smoke check doors, additional national regulations must be satisfied (where applicable).

* Subject to our current conditions of warranty and guarantee available at www.dorma.com. Copies will also be sent out on request.

Benefits at a glance

For the trade

- 5 years warranty on all products in the Pure series*
- Affordable door furniture featuring the most popular lever handle models
- Packaging of complete sets for easy stocking

For the installer

- Approved to EN 1906, category of use grade 3 and maximum corrosion resistance grade 4
- Just one screw length for door thicknesses of 38–56 mm
- All models are spring-assisted
- DORMA quality for long service life

Materials and finishes

Stainless steel fittings, S/S

Door furniture manufactured from stainless steel offers the advantages of not only high corrosion resistance but also exemplary resistance to mechanical wear and tear.

Available in

- satin

Anodised aluminium fittings, AL

Colour anodised on the basis on special formulations, Pure aluminium fittings exhibit high resistance, uniform oxide layers for effective protection against weathering and wear.

Available in

- F1 silver anodised

Rose and backplate dimensions

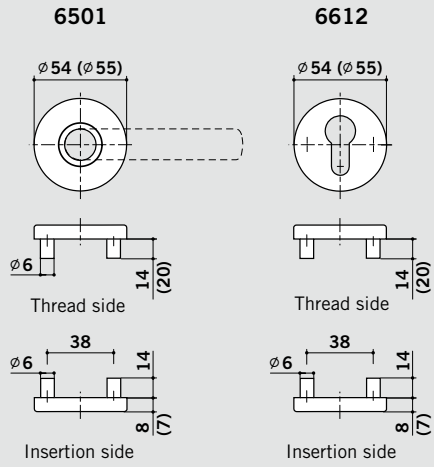

7122

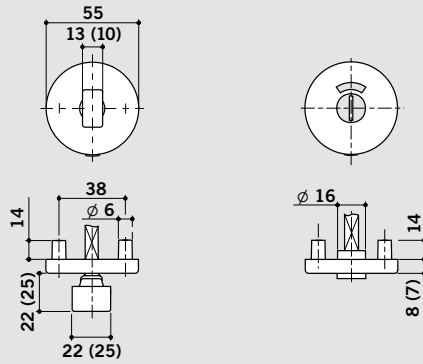

7051 K

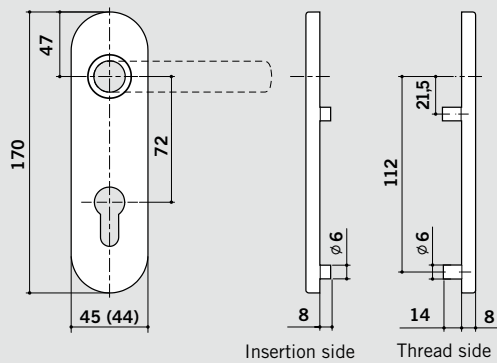

7051 K WC

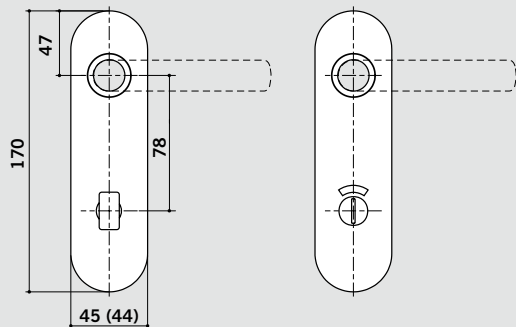

() = Dimensions for Alu

Oval rose dimensions

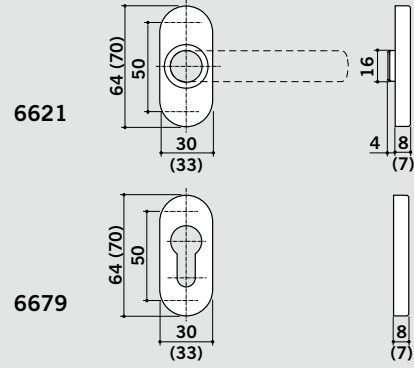

() = Dimensions for Alu

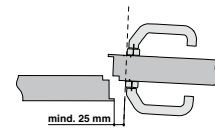

Please note:

A minimum clearance of 25 mm must be maintained between the lever handle and the frame stop.

For timber doors:

Supplied exclusively as complete set incl. fixing material..

For narrow stile doors:

Supplied exclusively as half set with loose spindle.

Other lock preparations and follower-to-keyway centres on application.

Handing data for entrance door sets

Lever handle/knob combination set, RH

Inside:
Lever handle points to right
Outside:
Knob points to left

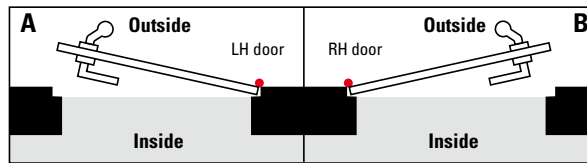

Lever handle/knob combination set, LH

Inside:
Lever handle points to left
Outside:
Knob points to right

Lever handle/knob combination set, RH

Inside:
Lever handle points to right
Outside:
Knob points to left

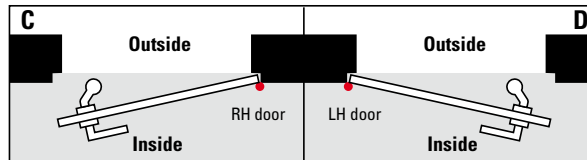

Lever handle/knob combination set, LH

Inside:
Lever handle points to left
Outside:
Knob points to right

Classification to EN 1906

	3	7	-	1*	1	4	0	A
Category of use Grades 1 to 4 Grade 3 High frequency of use by public or others with little incentive to exercise care and with a high chance of misuse, e.g. public office doors.								
Durability 6 = 100,000 cycles 7 = 200,000 cycles								
Door mass No classification								
Fire resistance 0 = No 1* = Yes								
Safety 0 = for normal use 1 = for safety applications								
								Type of operation A = spring assisted furniture B = spring-loaded furniture U = unsprung furniture
								Security 0 = not approved for use on burglary resistant doors
								Corrosion resistance 0 = no defined corrosion resistance 1 = mild resistance 2 = moderate resistance 3 = high resistance 4 = very high resistance

* When used with fire and smoke check doors, additional national regulations must be satisfied (where applicable).

Pure 8100

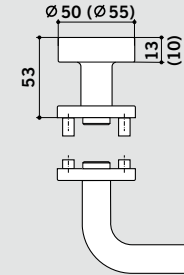
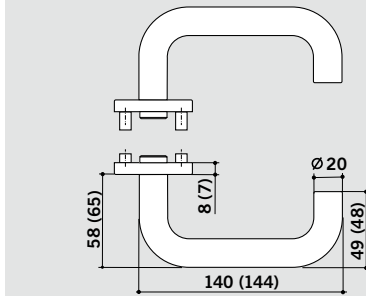

() = Dimensions for Alu

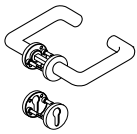

Pure 8100/
6501/6612

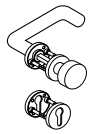

Pure 8100/
6501/3020/6612

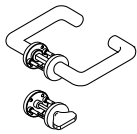

Pure 8100/
6501/7122

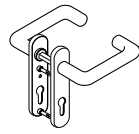

Pure 8100/
7051 K

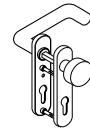

Pure 8100/
7051 K/3020

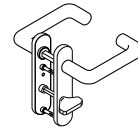

Pure 8100/
7051 K WC

Pure 8906

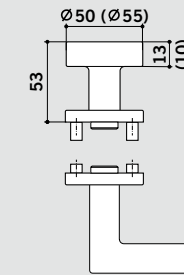
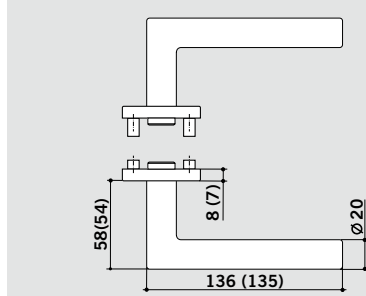
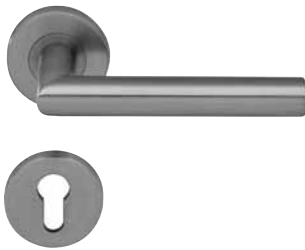

() = Dimensions for Alu

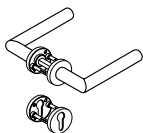

Pure 8906/
6501/6612

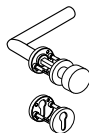

Pure 8906/
6501/3020/6612

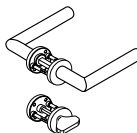

Pure 8906/
6501/7122

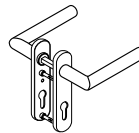

Pure 8906/
7051 K

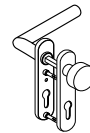

Pure 8906/
7051 K/3020

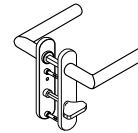

Pure 8906/
7051 K WC

Pure 8998

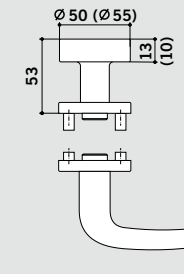
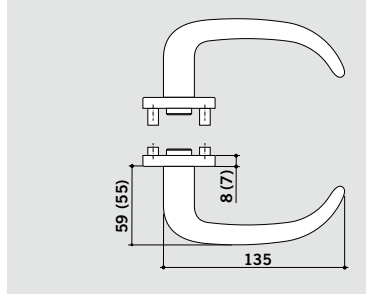

() = Dimensions for Alu



Pure 8998/
6501/6612

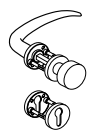

Pure 8998/
6501/3020/6612



Pure 8998/
6501/7122

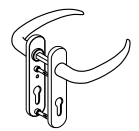

Pure 8998/
7051 K

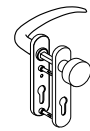

Pure 8998/
7051 K/3020

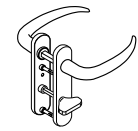

Pure 8998/
7051 K WC

Pure 8100

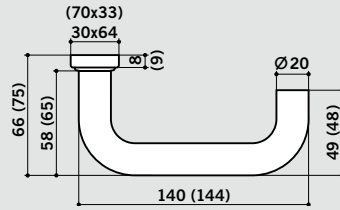
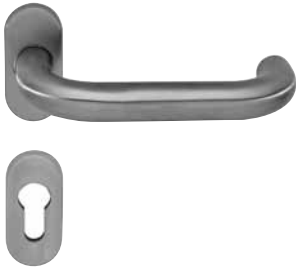

Pure 8100/6621/6679 PZ

() = Dimensions for Alu

Pure 8100 V

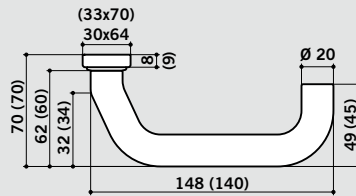
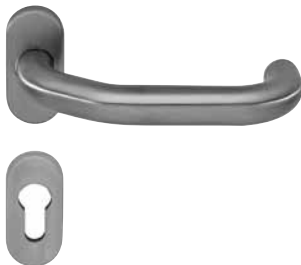

Pure 8100V/6621/6679 PZ

() = Dimensions for Alu

Pure 8906

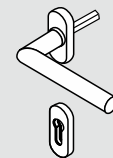
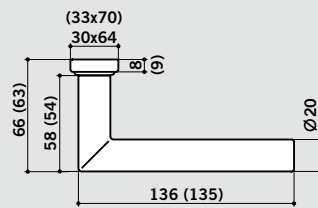

Pure 8906/6621/6679 PZ

() = Dimensions for Alu

Pure 3548 V fixed knob

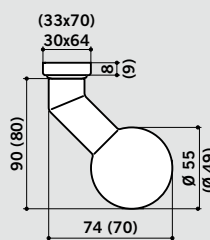

Pure 3548 V/6679 PZ

() = Dimensions for Alu



4 021226 804223



Door Control



Automatic



**Glass Fittings
and Accessories**



**Security/Time
and Access (STA)**



Movable Walls

Door Control Division worldwide

Central Europe

DORMA GmbH + Co. KG
DORMA Platz 1
D-58256 Ennepetal
Phone +49 2333 793-0
Fax +49 2333 793-495

Australasia

DORMA Door Controls Pty. Ltd.
52, Abbott Road
Hallam/Victoria 3803
Australia
Phone +61 3 8795 0666
Fax +61 3 8795 0280

China/Hong Kong

DORMA Door Controls
(Suzhou) Co. Ltd.
No. 9, Hong Feng Road
Suzhou Singapore Industrial Park
Suzhou, 215021
P.R. of China
Phone +86 512 67612481
Fax +86 512 67614582

DORMA Door Controls Pte. Ltd.
Room 701, Technology Plaza
651 King's Road
North Point
Hong Kong
Phone +852 25034632
Fax +852 28875370

Emerging Markets

DORMA GmbH + Co. KG
DORMA Platz 1
D-58256 Ennepetal
Phone +49 2333 793-0
Fax +49 2333 793-495

DORMA Door Controls (Pty.) Ltd.
Kings Court
4A Mineral Crescent
ZA-2000 Crown/Gauteng
South Africa
Phone +27 11 8300280
Fax +27 11 8300291

Far East

DORMA Far East Pte. Ltd.
No. 31 Gul Lane
Singapore 629425
Phone +65 6268 7633
Fax +65 6265 7995

France

DORMA France S.A.S.
Zone Europarc
Immeuble Mega 42
42, Rue Eugène Dupuis
F-94046 Créteil Cedex
Phone +33 1 41942400
Fax +33 1 41942401

DORMA Beschlagtechnik GmbH

Donnenberger Str. 2
D-42553 Velbert
Tel. +49 2053 495-0
Fax +49 2053 495-100

Gulf

DORMA Gulf Door Controls FZE
Jebel Ali Free Zone South
Plot No. S 20135
Road No. SW 301 G
P.O. Box 17268
Dubai - United Arab Emirates
Phone +971 4 8020400
Fax +971 4 8869100 /
8869101

North America

DORMA Architectural Hardware
DORMA Drive, Drawer AC
Reamstown, PA 17567-0411
Phone +1 800 5238483
Fax +1 800 2749724

Scanbalt

DORMA Danmark A/S
Sindalvej 6-8
DK-2610 Rødovre
Phone +45 44 543000
Fax +45 44 543001

South America

DORMA Sistemas de Controles
para Portas Ltda.
Av. Piracema, 1400
Centro Empresarial Tambore
CEP 06400-933 Barueri/
São Paulo, Brasil
Phone +55 11 46899280
Fax +55 11 46899215

South-East Europe

DORMA AUSTRIA GmbH
Pebering Strass 22
A-5301 Eugendorf
Phone +43 6225 284880
Fax +43 6225 28491

South Europe

DORMA Italiana S.r.l.
Via. Canova 44/46
I-20035 Lissonne (MI)
Phone +39 039 244031
Fax +39 039 2440310

DORMA Ibérica, S.A.
Camino San Martin de la Vega, 4
E-28500 Arganda del Rey
(Madrid)
Phone +34 91 8757850
Fax +34 91 8757881

UK/Ireland

DORMA UK Ltd.
Wilbury Way
Hitchin
GB-Hertfordshire SG4 0AB
Great Britain
Phone +44 1462 477600
Fax +44 1462 477601