

**ALEXA**

**Türzargen  
Door frames**

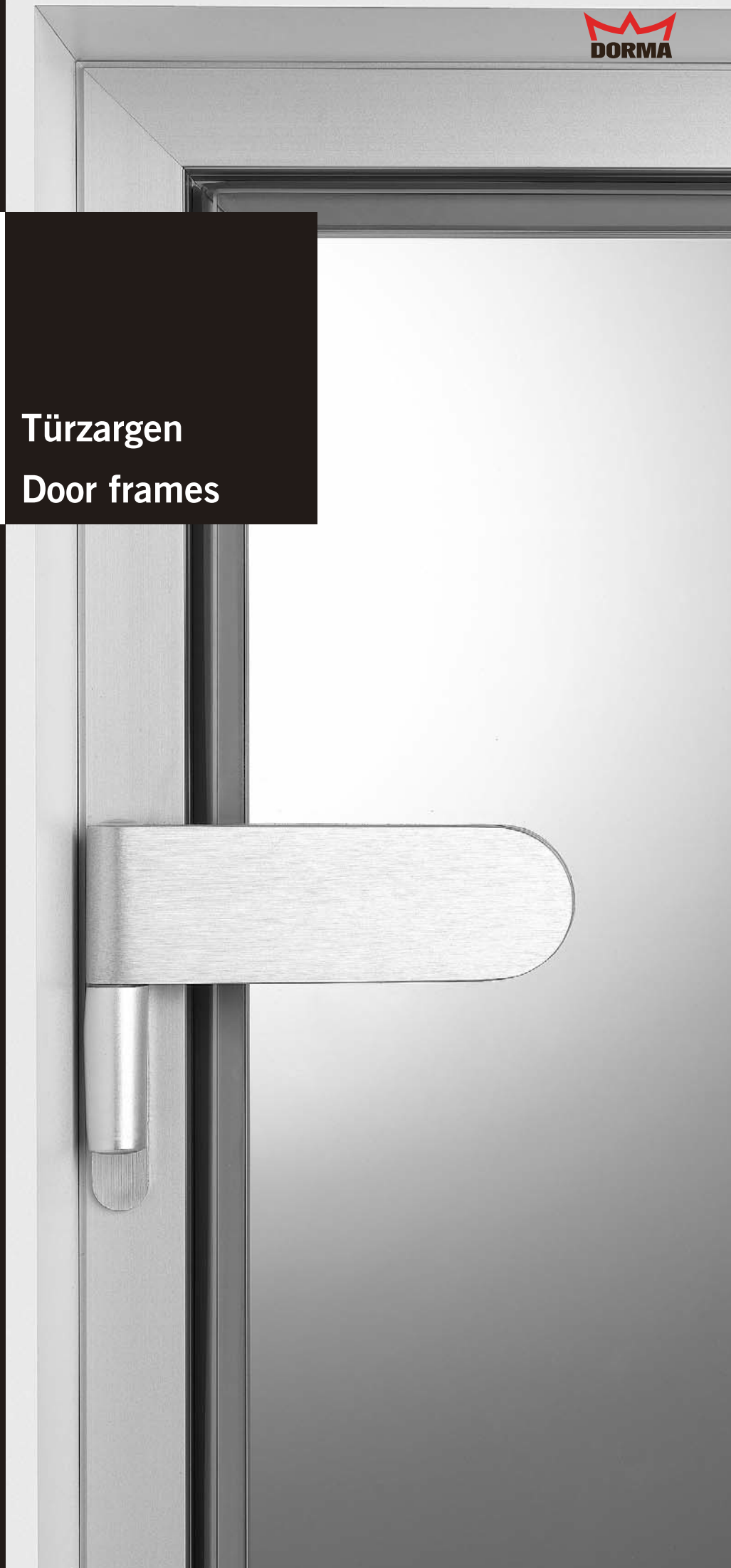

## Inhalt / Content

### **ALEXA AT 23**

Anschlagtürzarge

single acting door frame

ALEXA AT 23 E

Eckanschlagtürzarge

corner single acting door frame

Seiten / pages 4 - 9

### **ALEXA AT 44**

Anschlagtürzarge

single acting door frame

Seiten / pages 10 - 15

### **ALEXA AT 50**

freistehende Anschlagtürzarge

free standing connecting door frame

Seiten / pages 16 - 19

Zubehör / Accessories **MR 28, MR 22**

Seiten / pages 20 - 21

### **ALEXA PT 35**

Pendeltürzarge / double acting door frame

Seiten / pages 22 - 27

**Neu und superschmal –  
die perfekten Alu-Türzargen  
für Ganzglastüranlagen:**

- ALEXA AT 23  
Anschlagtürzarge
- ALEXA AT 23 E  
Eckanschlagtürzarge
- ALEXA AT 44  
Anschlagtürzarge
- ALEXA AT 50  
freistehende  
Anschlagtürzarge
- ALEXA PT 35  
Pendeltürzarge

Alle Zargentypen sind auf die passenden DORMA-Glas Beschläge abgestimmt. Bei den Anschlagtürzargen AT 44 und AT 50 werden die Standard-Beschläge mit 24 mm Falztiefe verwendet.

**Standard-Oberflächen**

- LM silber EV1 (101)
- LM ähnlich Niro matt (113)

**Hinweis für Maßfertigung**

Alle ALEXA Zargen werden nach Ihren Maßangaben gefertigt. Je nach Anlagen-Typ werden 2, 3 oder 4 Maße benötigt (siehe technische Information und Bestellformular). Damit können alle Türrahmenvarianten erstellt werden.

Die Zargen werden für die bauseitige Montage vorge richtet.

**Bitte beachten:**

**Die Beschläge müssen  
gesondert bestellt werden.**

Technische Änderungen vorbehalten.



**New and super narrow –  
the perfect aluminium door  
frame for glass assemblies:**

- ALEXA AT 23  
single acting door frame
- ALEXA AT 23 E  
corner single acting door  
frame
- ALEXA AT 44  
single acting door frame
- ALEXA AT 50  
free standing  
connecting door frame
- ALEXA PT 35  
double acting door frame

All frame types have been tuned to fit DORMA-Glas fittings. Standard fittings for a rebate depth of 24 mm are used on the single acting door frames AT 44 and AT 50.

**Standard finishes**

- aluminium silver EV1 (101)
- aluminium similar satin stainless steel (113)

**Note regarding customising**

All ALEXA frames are produced to your given measurements. 2, 3 or 4 measurements are needed depending on system type (see technical information and order sheet). With this, it is possible to plan all door frame types.

Door frames are prepared for on site assembly.

**Please note:**

**Fittings have to be ordered  
separately.**

Subject to change without notice.

**ALEXA AT 23**  
Anschlagtürzarge

## für 8 / 10 mm Glas

Mit verdeckter Befestigung, passend für DORMA Spezialbänder Art.-Nr. 11.294, 12.050, 25.450 und Schlösser aus der Studio bzw. Office Serie sowie für DORMA MEDIO.

**Max. Türgewicht**

- mit 2 Bändern = 40 kg
- mit 3 Bändern = 55 kg

**Standard-Oberflächen**

- LM silber EV1 (101)
- LM ähnlich Niro matt C 31 (113)

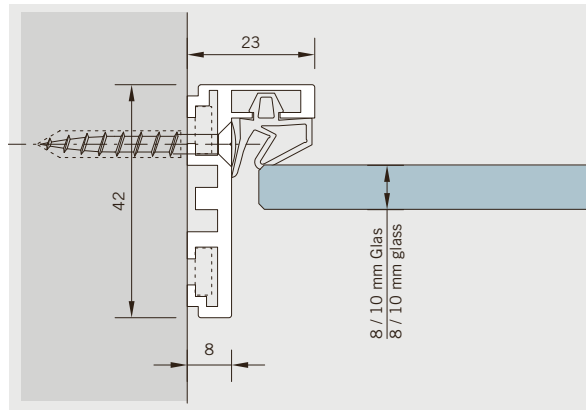
**ALEXA AT 23 single acting**  
door frame

## for 8 / 10 mm glass

With concealed fixing and suitable for DORMA special hinges Art. No. 11.294, 12.050, 25.450 and locks Studio respectively Office serie as well as for DORMA MEDIO.

**Max. door weight**

- with 2 hinges = 40 kg
- with 3 hinges = 55 kg

**Standard finishes**

- aluminium silver EV1 (101)
- aluminium similar satin stainless steel C 31 (113)

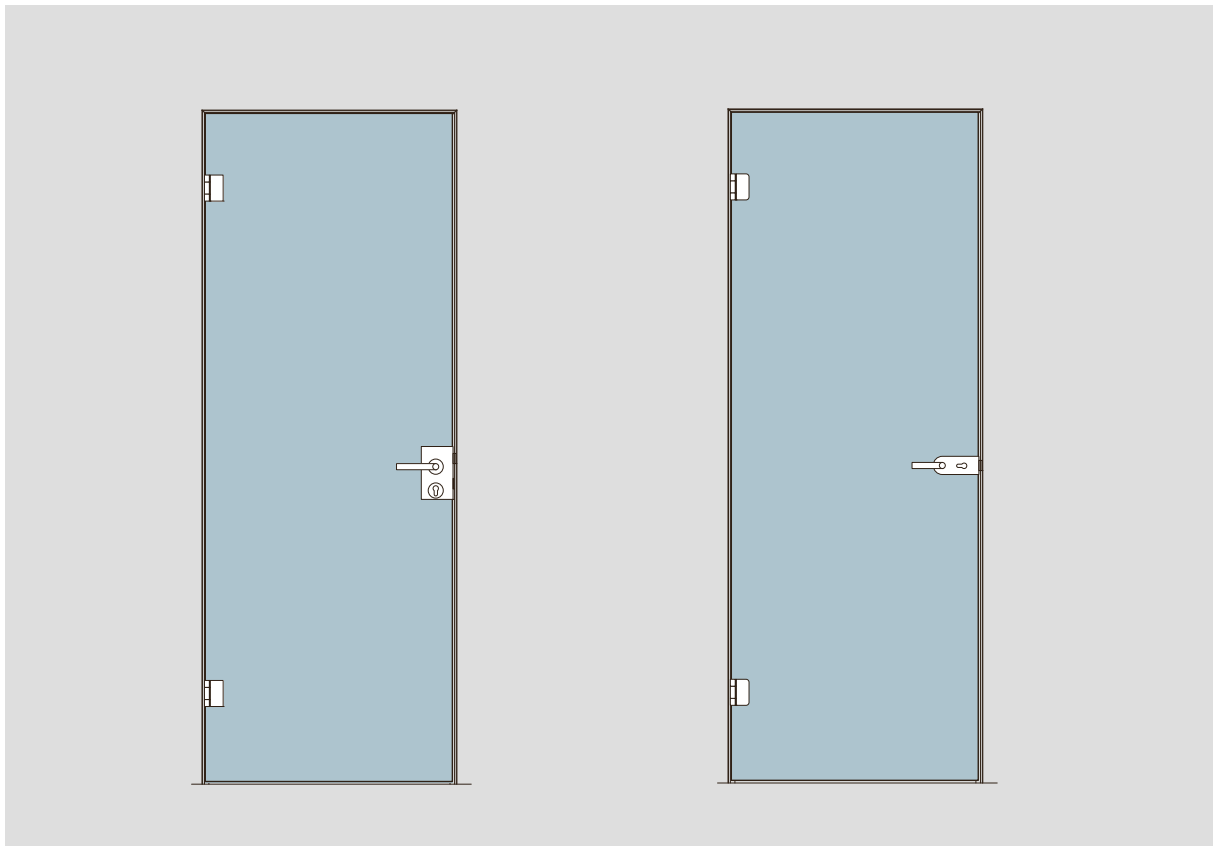

**ALEXA AT 23 E**  
**Eckanschlagtürzarge**
**für 8 / 10 mm Glas**

Mit verdeckter Befestigung, passend für DORMA Spezialbänder Art.-Nr. 11.294, 12.050, 25.450 und Schlösser aus der Studio bzw. Office Serie sowie für DORMA MEDIO.

**Max. Türgewicht**

- mit 2 Bändern = 40 kg
- mit 3 Bändern = 55 kg

**Standard-Oberflächen**

- LM silber EV1 (101)
- LM ähnlich Niro matt C 31 (113)

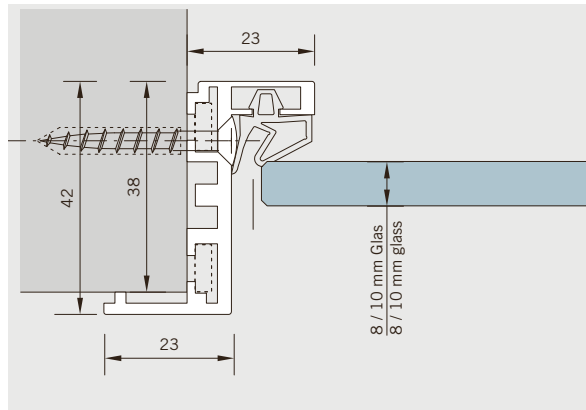
**ALEXA AT 23 E corner**  
**single acting door frame**
**for 8 / 10 mm glass**

With concealed fixing and suitable for DORMA special hinges Art. No. 11.294, 12.050, 25.450 and locks Studio respectively Office serie as well as for DORMA MEDIO.

**Max. door weight**

- with 2 hinges = 40 kg
- with 3 hinges = 55 kg

**Standard finishes**

- aluminium silver EV1 (101)
- aluminium similar satin stainless steel C 31 (113)

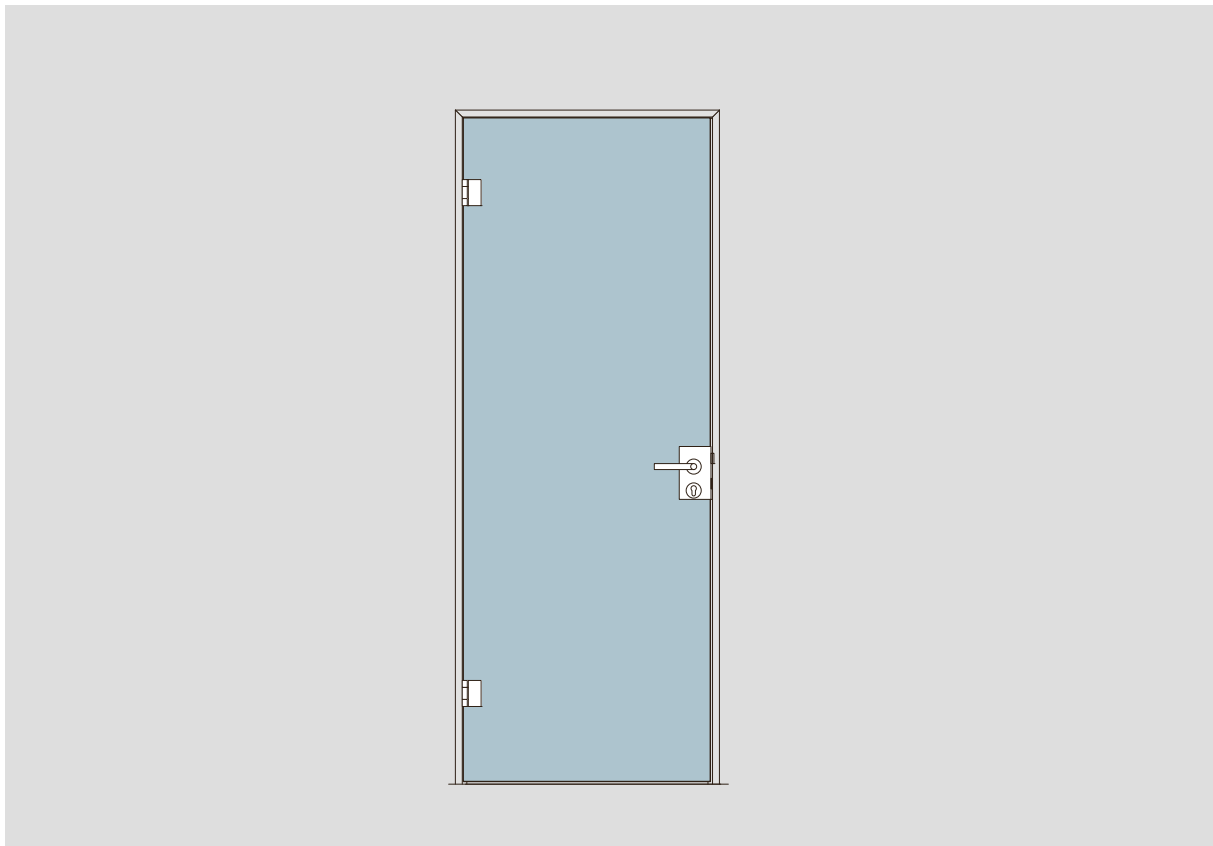

## Beschlagvarianten-Beispiele / Fitting type examples

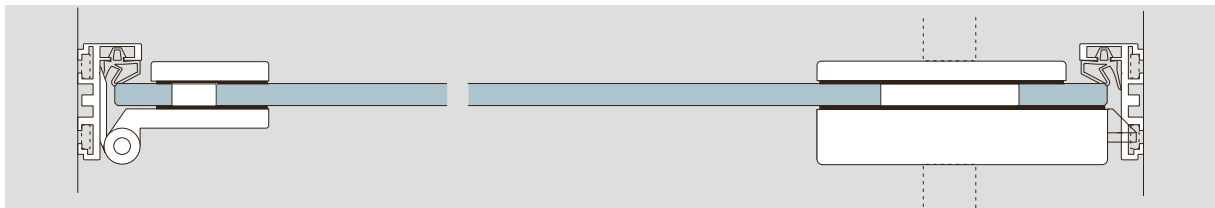

ALEXA AT 23 mit DORMA Spezialband Art.-Nr. 11.294 bzw. 12.050, Schloss (Junior Office, Junior Office Classic)  
 ALEXA AT 23 with DORMA special hinge Art. No. 11.294 resp. 12.050, lock Junior Office / Junior Office Classic

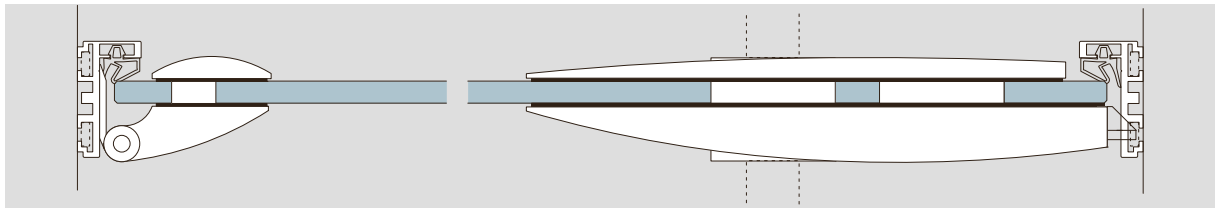

ALEXA AT 23 mit DORMA Spezialband ARCOS Art.-Nr. 25.450, Schloss ARCOS Studio  
 ALEXA AT 23 with DORMA special hinge ARCOS Art. No. 25.450, lock ARCOS Studio

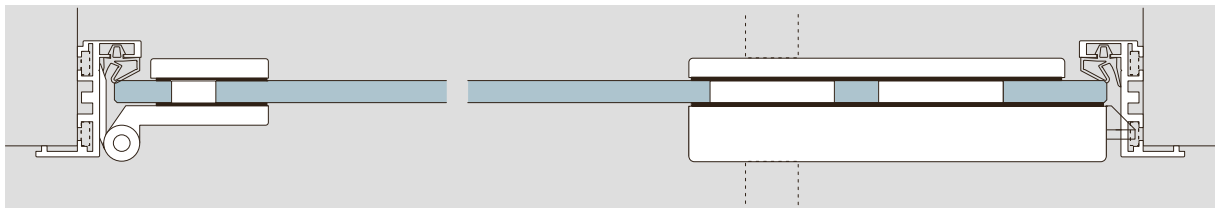

ALEXA AT 23 E mit DORMA Spezialband Art.-Nr. 11.294 bzw. 12.050, Schloss Studio (Rondo, Classic)  
 ALEXA AT 23 E with DORMA special hinge Art. No. 11.294 resp. 12.050, lock Studio Rondo / Classic

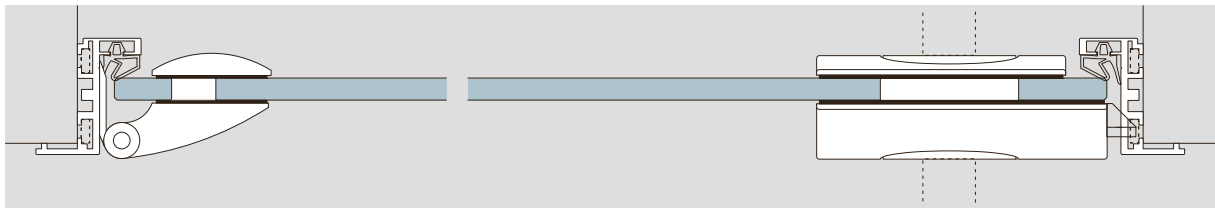

ALEXA AT 23 E mit DORMA Spezialband ARCOS Art.-Nr. 25.450, Schloss ARCOS Office  
 ALEXA AT 23 E with DORMA special hinge ARCOS Art. No. 25.450, lock ARCOS Office

## ALEXA AT 23 Anschlagtürzarge / single acting door frame

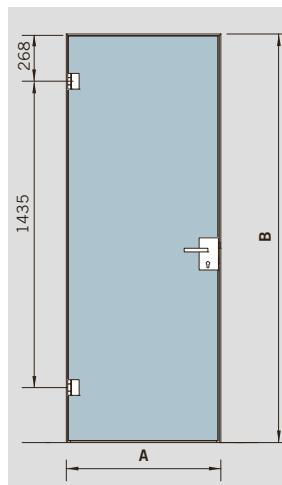
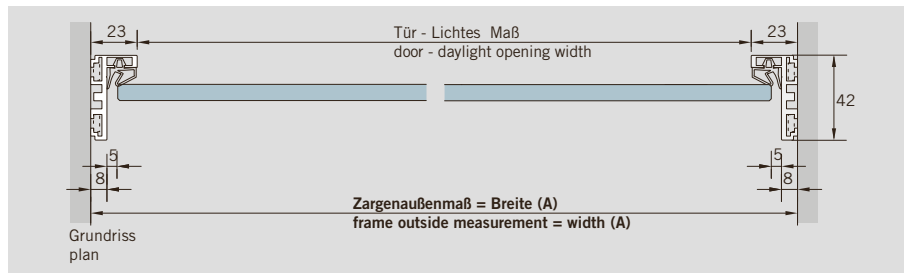
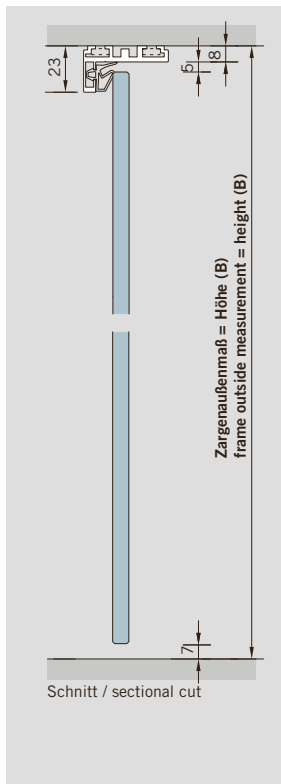

Beispiel für die Maßangaben und definierte Standardmaße für Bänder und Türdrücker.  
Example for measurements and set standard measurements for hinges and door levers.

## ALEXA AT 23 E Eckanschlagtürzarge / corner single acting door frame

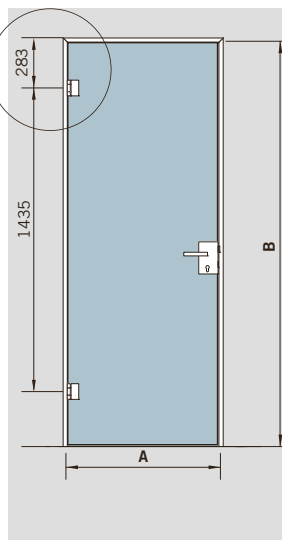
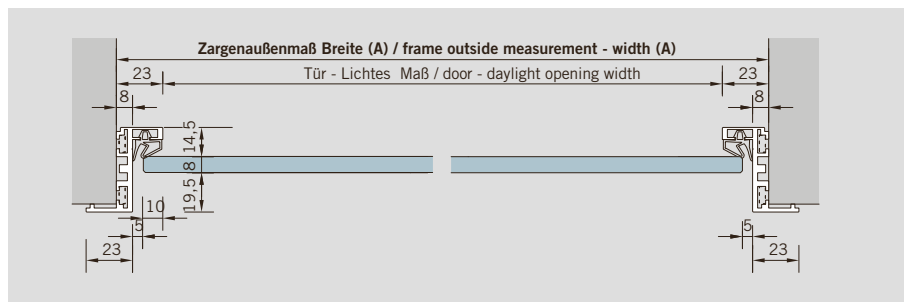
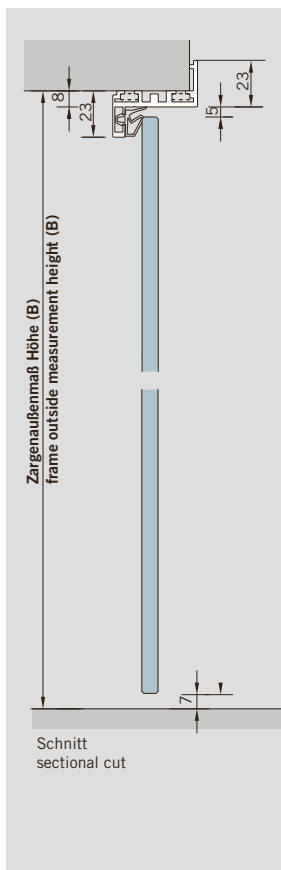

Beispiel für die Maßangaben und definierte Standardmaße für Bänder und Türdrücker.  
Example for measurements and set standard measurements for hinges and door levers.

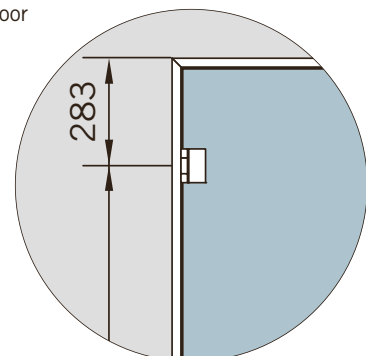

ALEXA AT 23 Anschlagtürzarge / single acting door frame

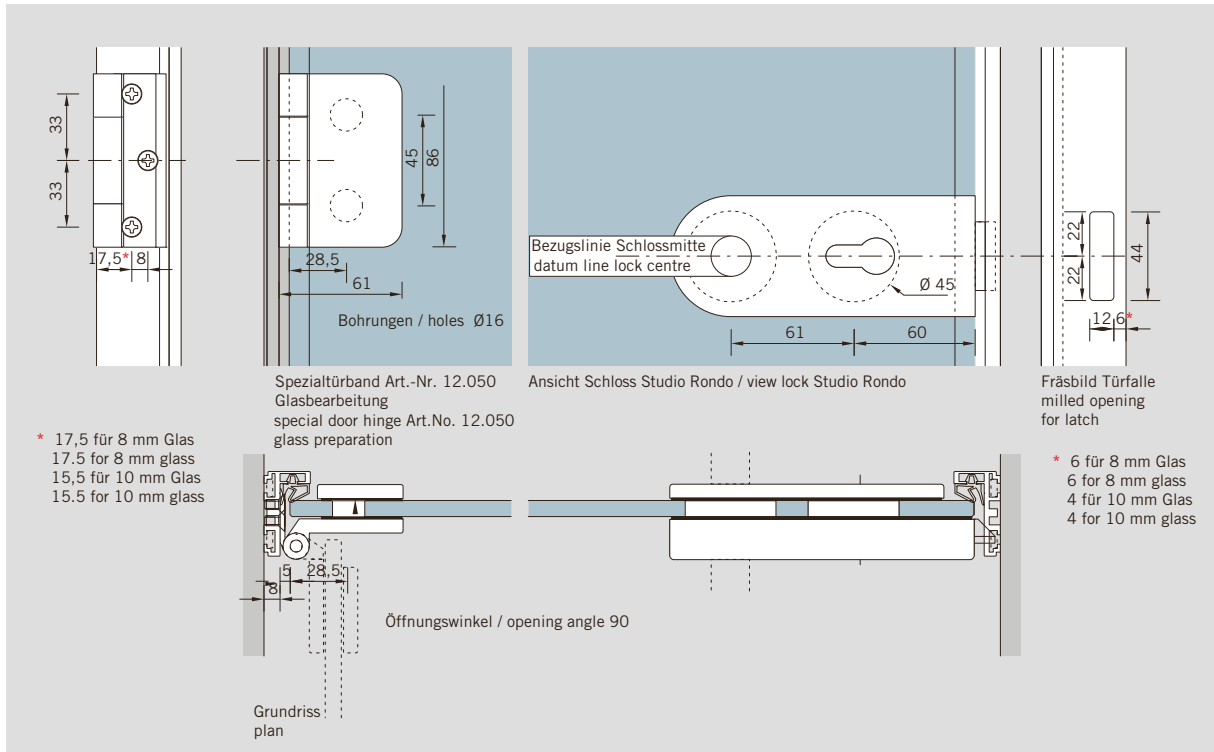

ALEXA AT 23 E Eckanschlagtürzarge / corner single acting door frame

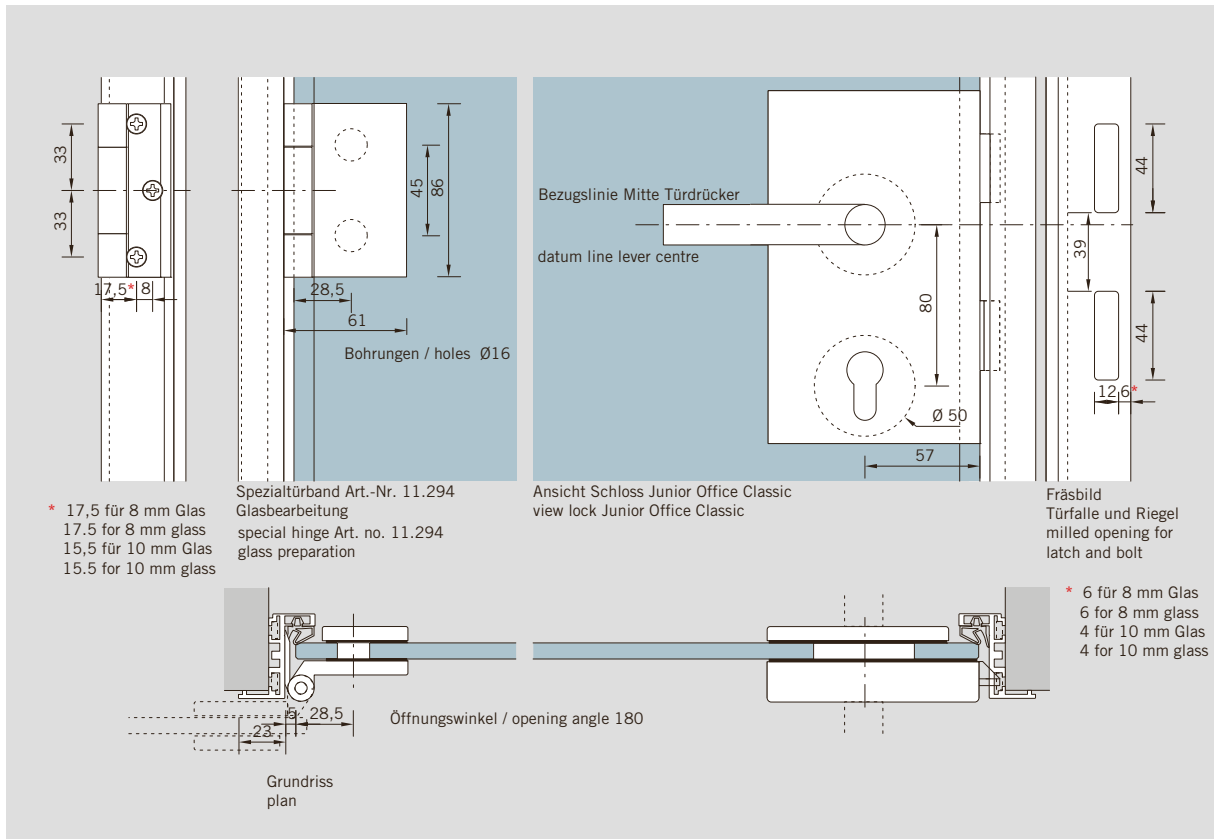



## ALEXA AT 23 Anschlagtürzarge / single acting door frame

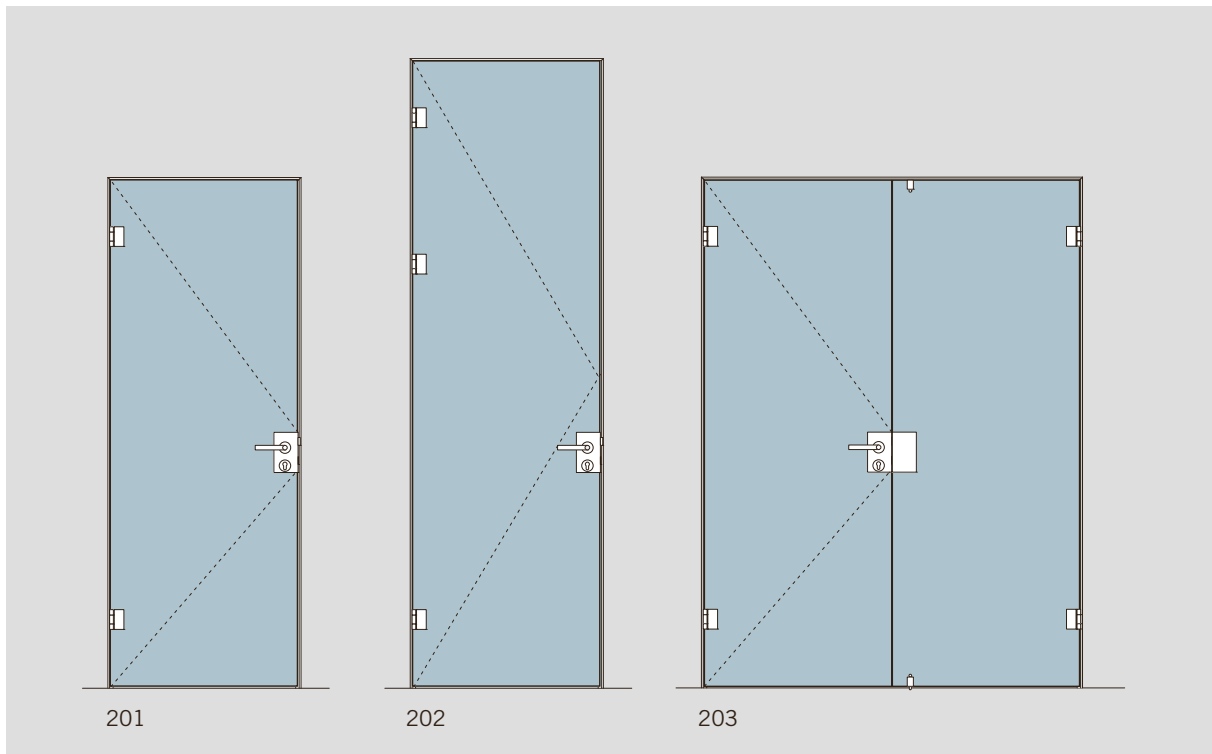

## ALEXA AT 23 E Eckanschlagtürzarge / corner single acting door frame

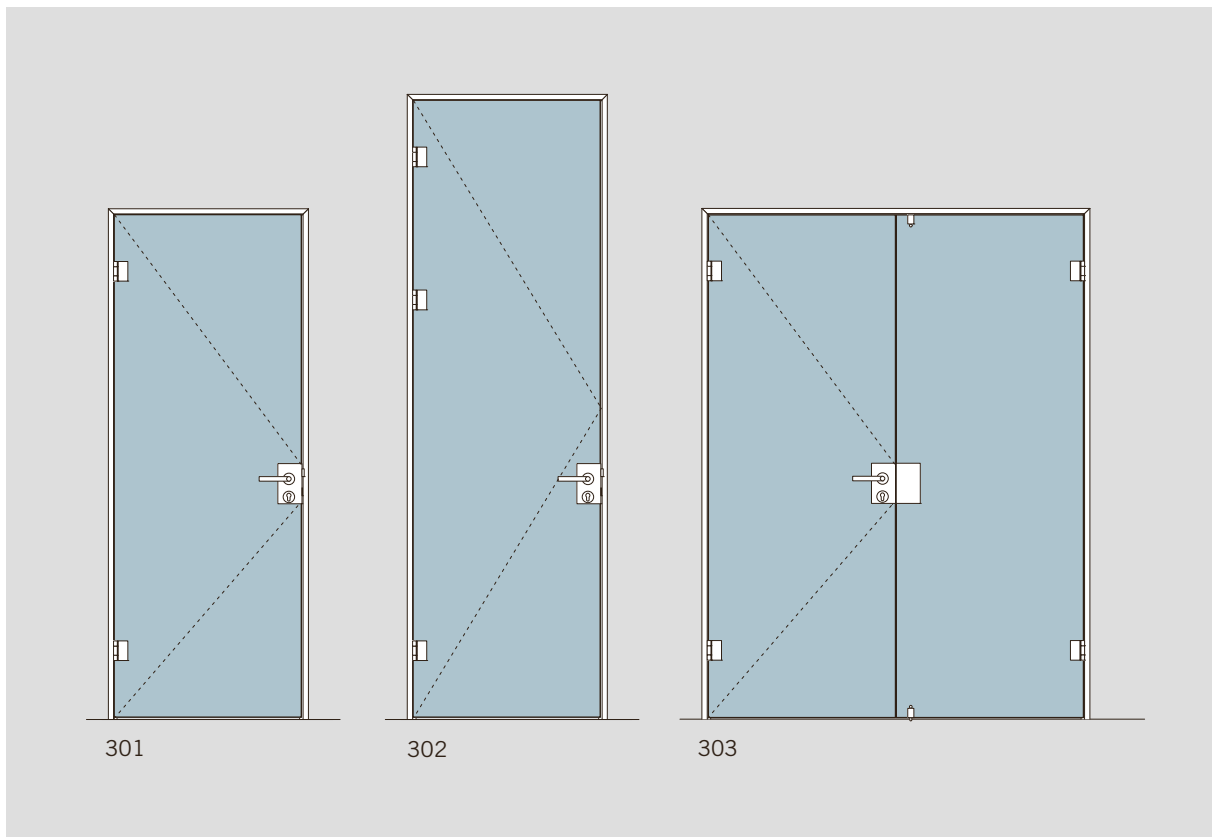

**ALEXA AT 44 –  
Anschlagtürzarge für  
8 / 10 mm Glas**

Mit verdeckter Befestigung für ein- und doppelflügelige Türanlagen, mit Oberlicht und/oder festen Seitenteilen.

Passend für DORMA Office (ARCOS, Jubior, Classic), Studio (ARCOS, Rondo, Classic, Gala) sowie für MEDIO.

**Max. Türgewicht**  
45 bis 65 kg

**Standard-Oberflächen**

- LM silber EV1 (101)
- LM ähnlich Niro matt C 31 (113)

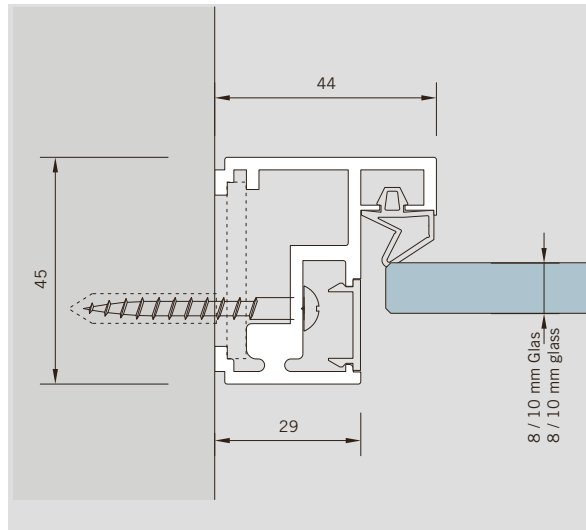
**ALEXA AT 44 –  
single acting door frame  
for 8 / 10 mm glass**

With concealed fixing for single and double action door assemblies, with over-panel and/or fixed sidelights.

Suitable for DORMA Office (ARCOS, Jubior, Classic), Studio (ARCOS, Rondo, Classic, Gala) as well as for MEDIO.

**Max. door weight**  
45 up to 65 kg

**Standard finishes**

- aluminium silver EV1 (101)
- aluminium similar satin stainless steel C 31 (113)

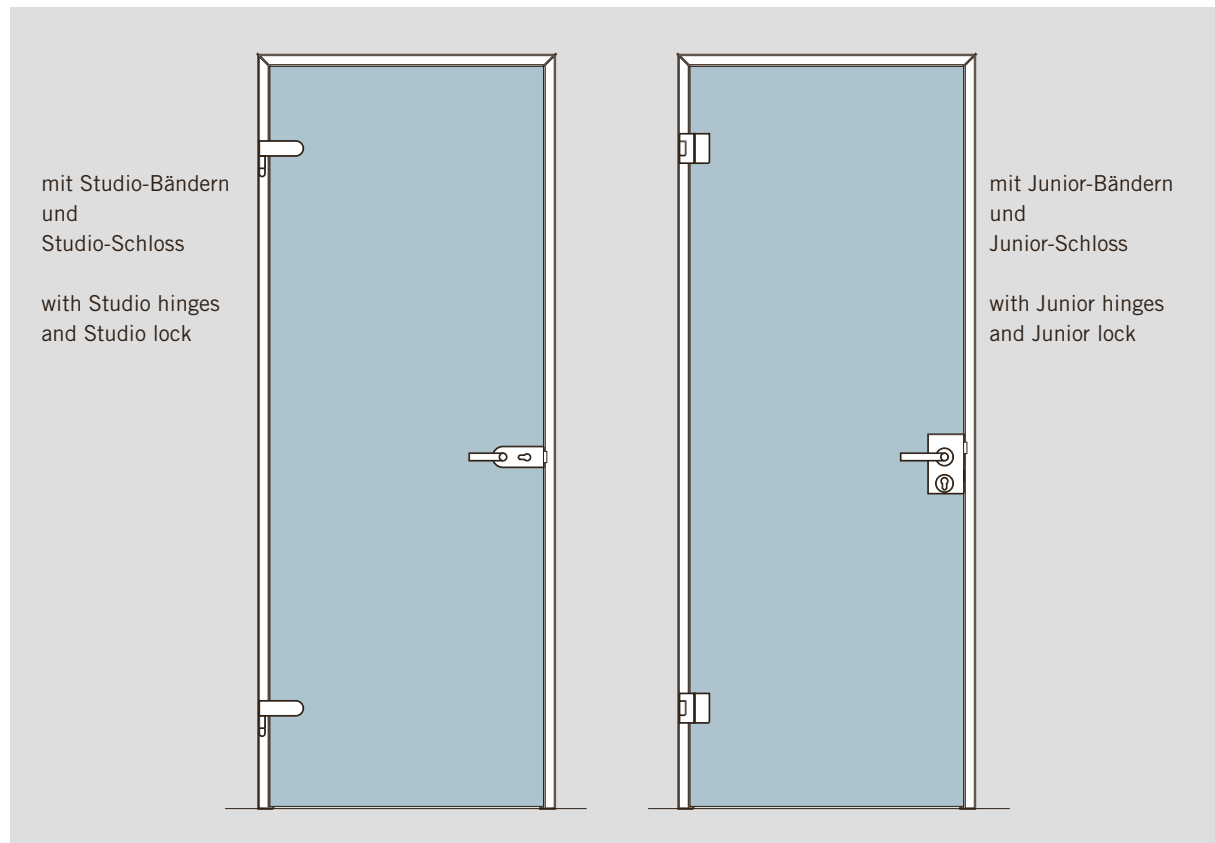
**AT 44 – Zargenprofil 3-seitig / frame profile 3-sided**

Die Profile / The Profiles

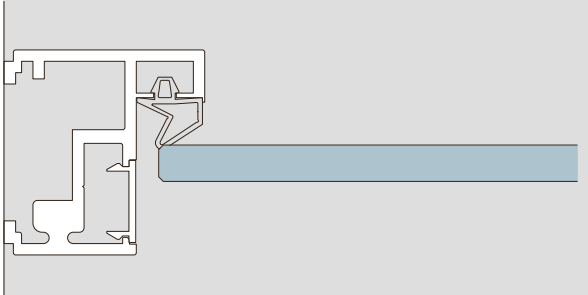

ALEXA AT 44 - Zargenprofil  
ALEXA AT 44 - frame profile

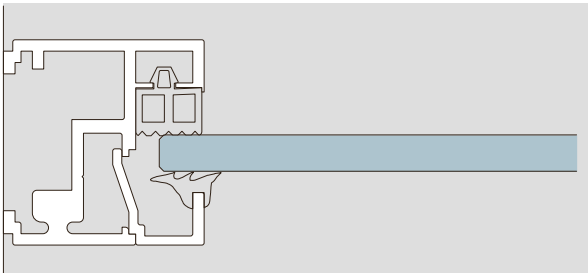

ALEXA AT 44 - Festverglasung  
ALEXA AT 44 - fixed glass

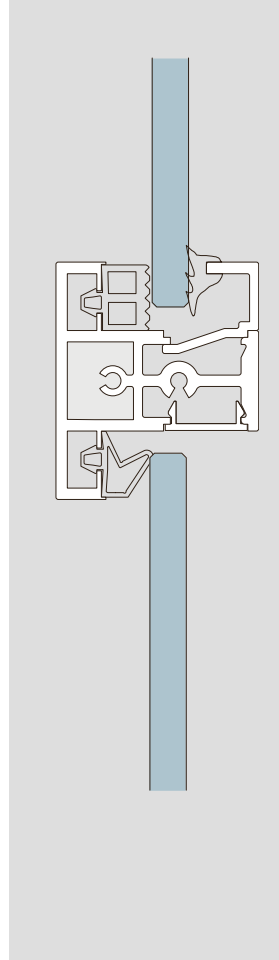

Sprossenprofil  
Rung profile

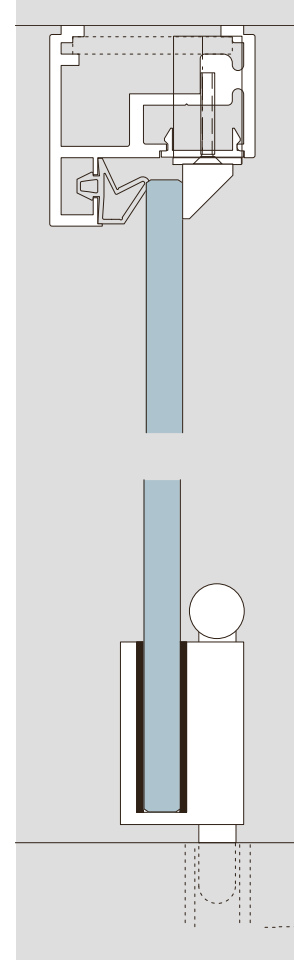

Zargenprofil  
Frame profile

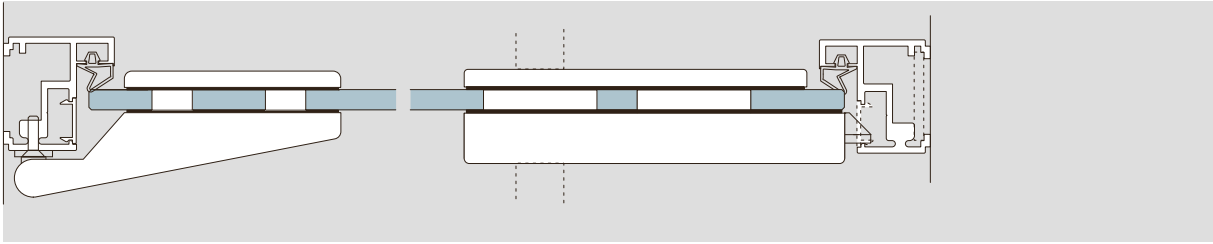
**Beschlagtypen Beispiele / Fitting types examples**

ALEXA AT 44 - mit DORMA Studio (Classic, Rondo)  
 ALEXA AT 44 - with DORMA Studio (Classic, Rondo)

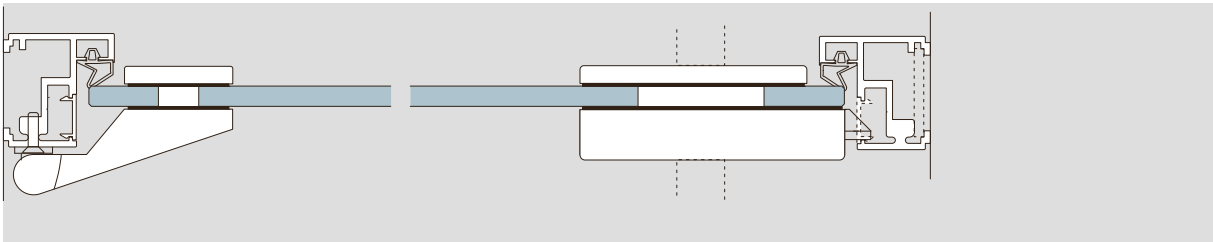

ALEXA AT 44 - mit DORMA Junior (Office, Office Classic)  
 ALEXA AT 44 - with DORMA Junior (Office, Office Classic)

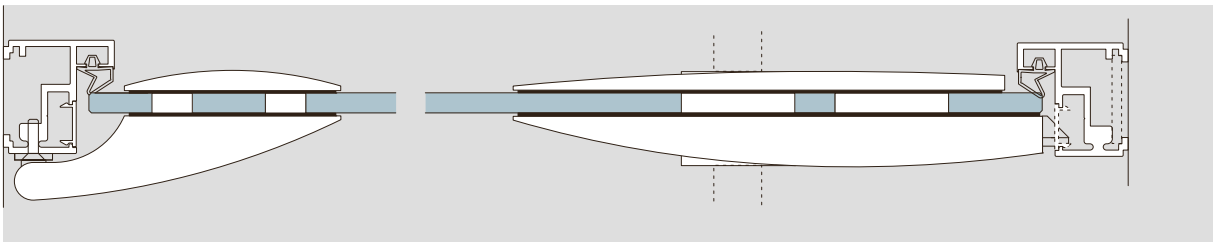

ALEXA AT 44 - mit DORMA ARCOS Studio  
 ALEXA AT 44 - with DORMA ARCOS Studio

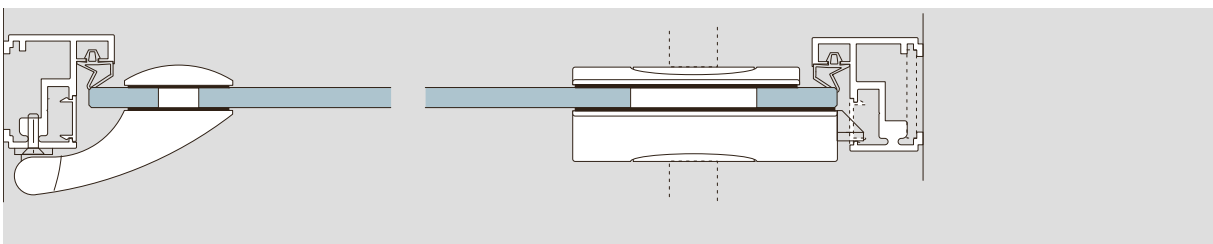

ALEXA AT 44 - mit ARCOS Office  
 ALEXA AT 44 - with ARCOS Office

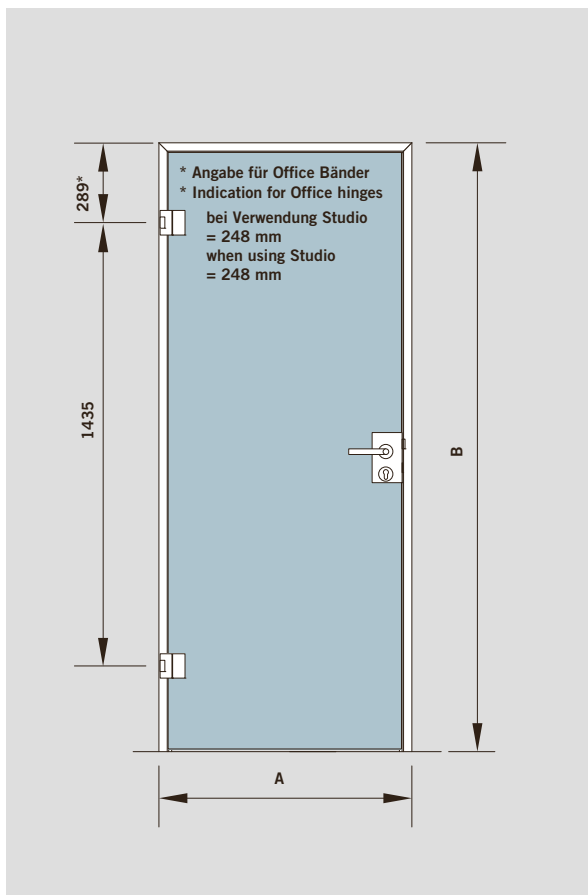
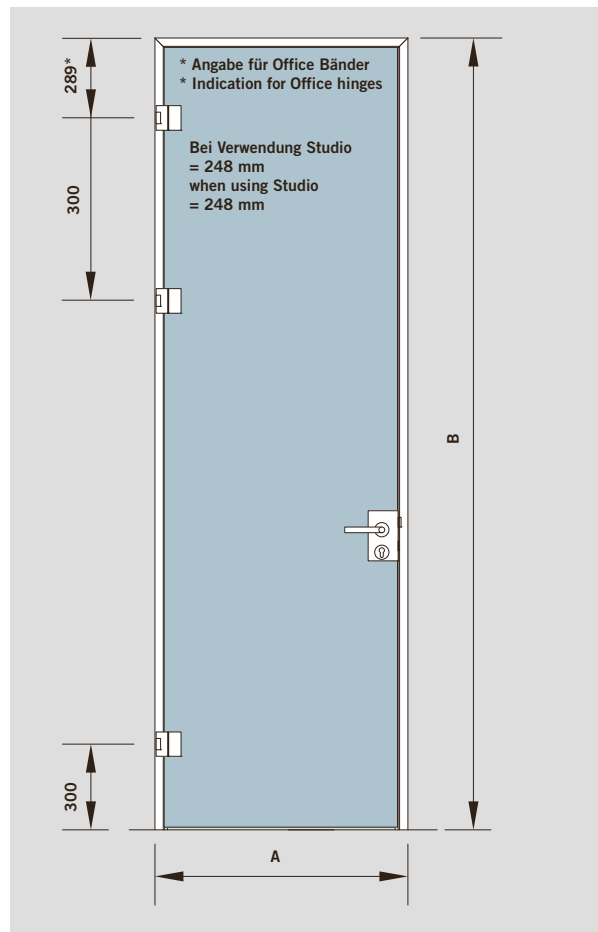
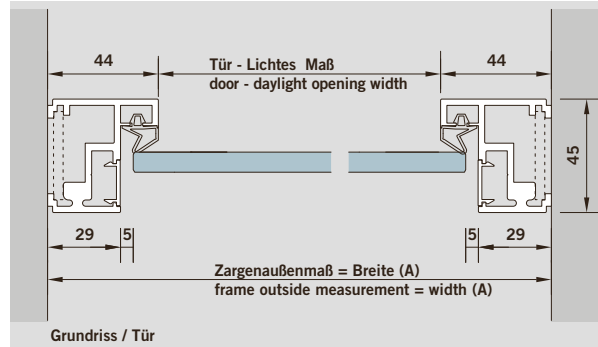
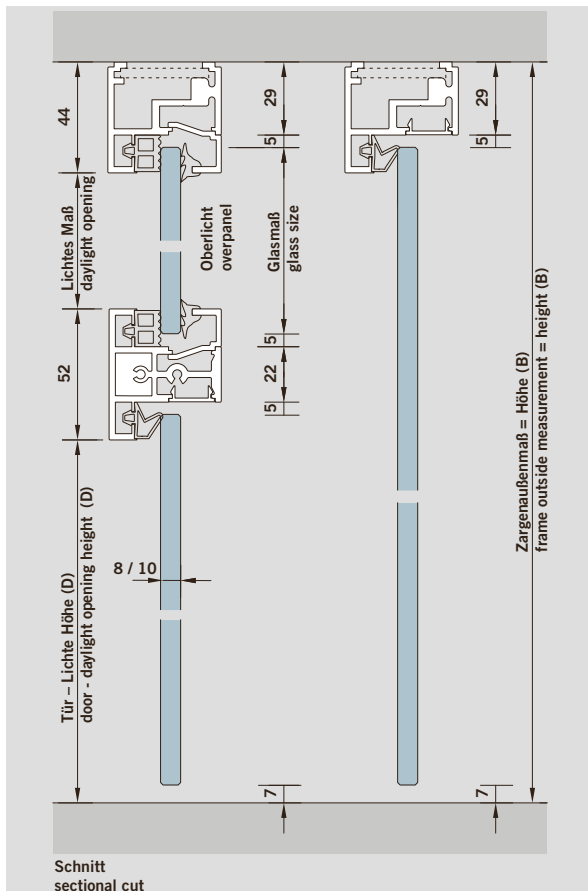

#### Beispiel für die Maßangaben und definierte Standardmaße für Bänder und Türdrücker

##### Max. Türgewicht

- Junior Varianten - mit 2 Bändern = 55 kg
- Junior Varianten - mit 3 Bändern = 65 kg
- Studio Varianten - mit 2 Bändern = 45 kg
- Studio Varianten - mit 3 Bändern = 50 kg

#### Example for measurements and set standard measurements for hinges and door levers

##### Max. door weight

- Junior types - with 2 hinges = 55 kg
- Junior types - with 3 hinges = 65 kg
- Studio types - with 2 hinges = 45 kg
- Studio types - with 3 hinges = 50 kg

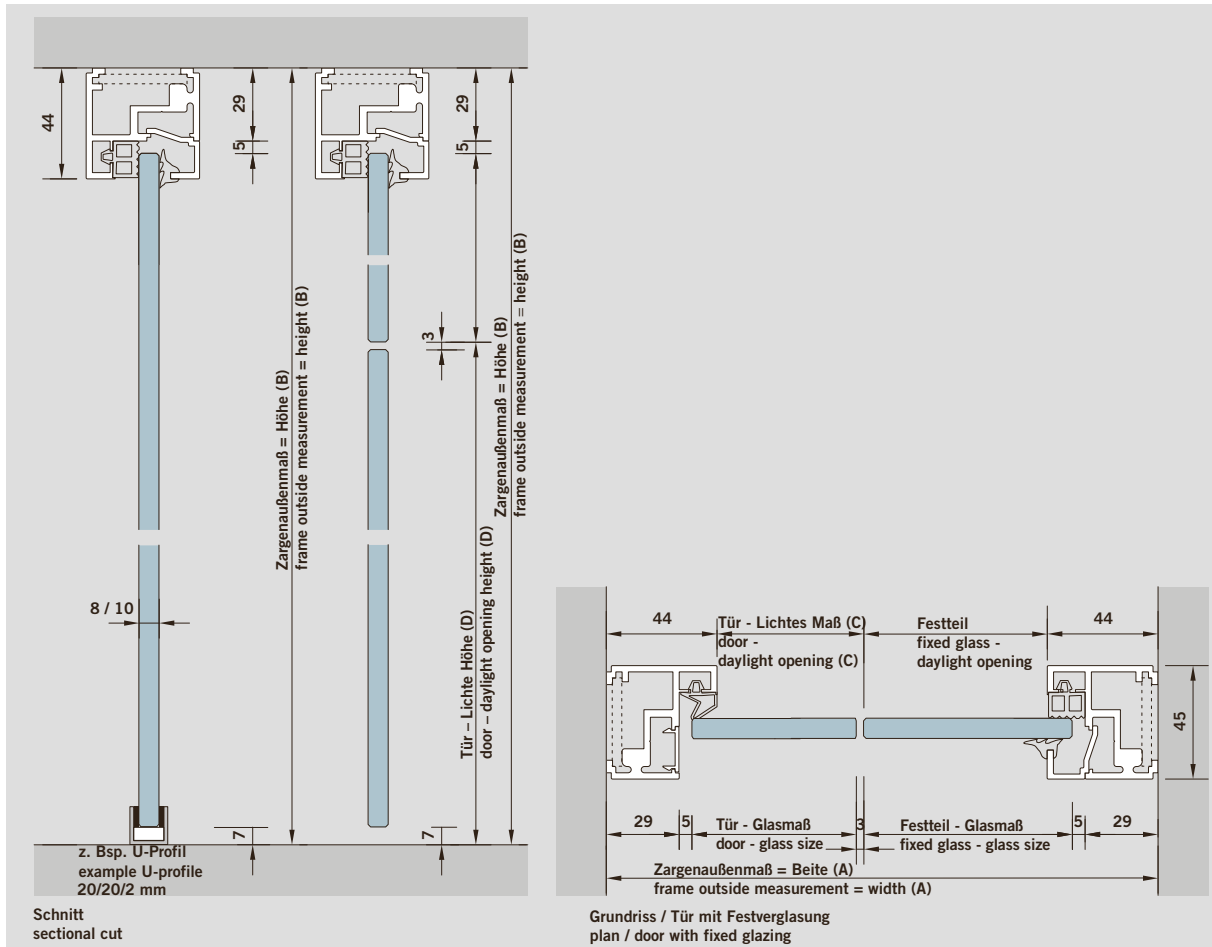
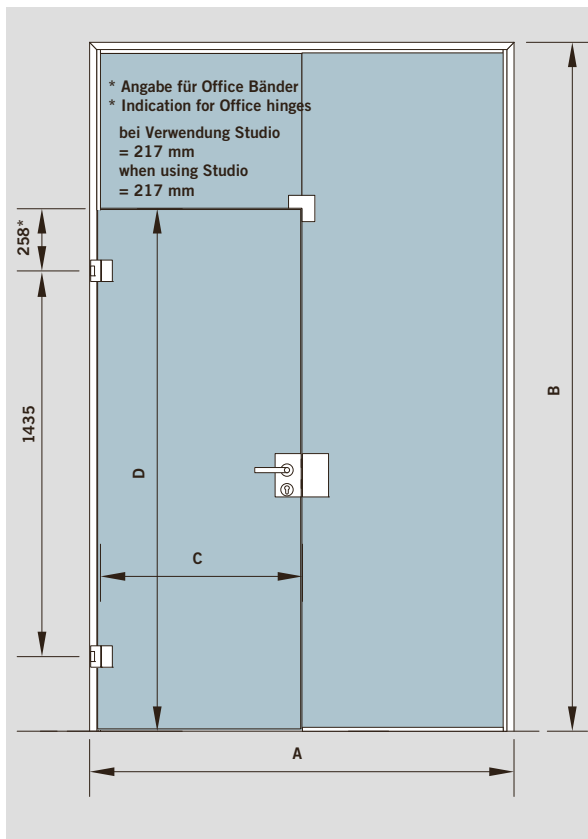
Schnitt  
sectional cutGrundriss / Tür mit Festverglasung  
plan / door with fixed glazing

### Beispiel für die Maßangaben und definierte Standardmaße für Bänder und Türdrücker

#### Max. Türgewicht

- Junior Varianten - mit 2 Bändern = 55 kg
- Junior Varianten - mit 3 Bändern = 65 kg
- Studio Varianten - mit 2 Bändern = 45 kg
- Studio Varianten - mit 3 Bändern = 50 kg

### Example for measurements and set standard measurements for hinges and door levers

#### Max. door weight

- Junior types - with 2 hinges = 55 kg
- Junior types - with 3 hinges = 65 kg
- Studio types - with 2 hinges = 45 kg
- Studio types - with 3 hinges = 50 kg

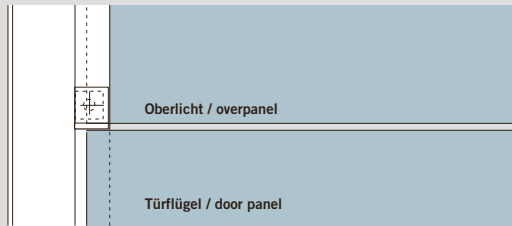

Oberlichtbefestigung / overpanel fixing  
Haltewinkel justierbar / adjustable angle bracket

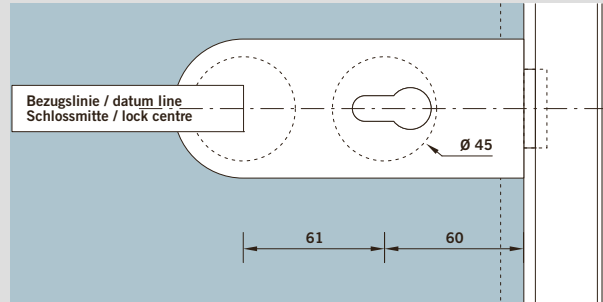
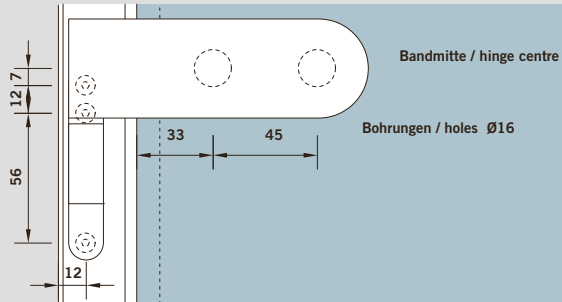

Ansicht Schloss Studio Rondo  
view lock Studio Rondo

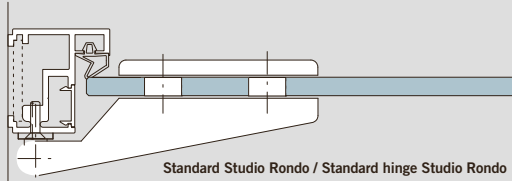

Standard Studio Rondo / Standard hinge Studio Rondo

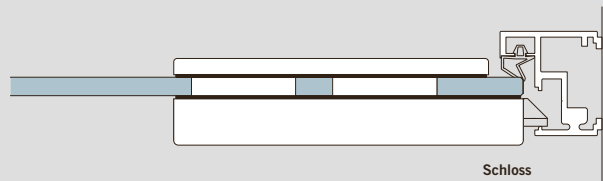

Schloss  
lock

Studio Rondo mit Anschraub-Rahmenteil  
Studio Rondo with screw-on frame pivot

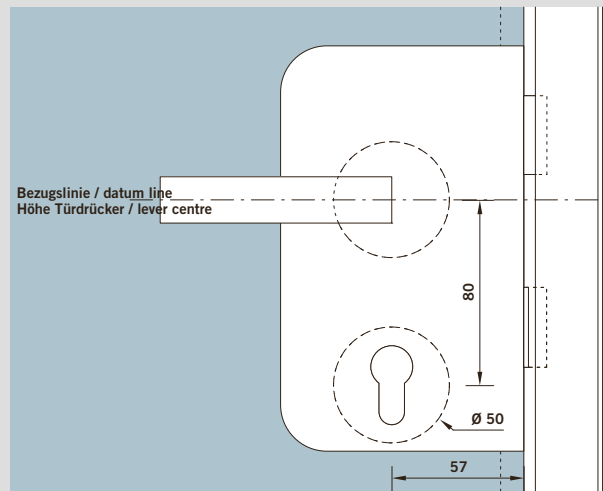
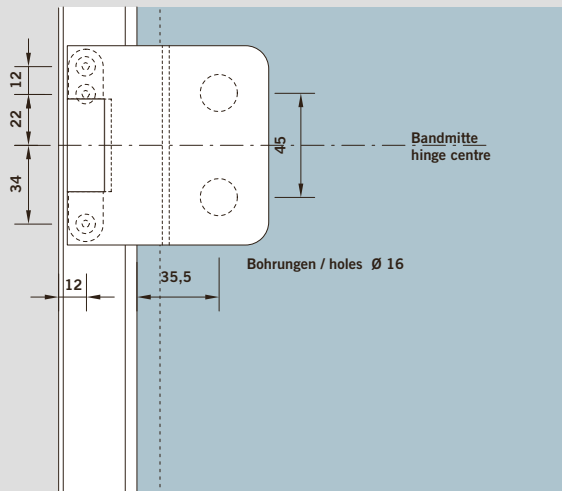

Ansicht Schloss Junior Office  
view lock Junior Office

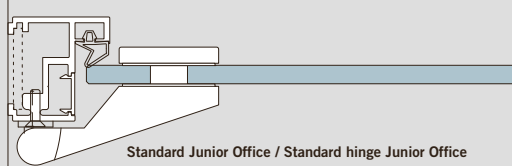

Standard Junior Office / Standard hinge Junior Office

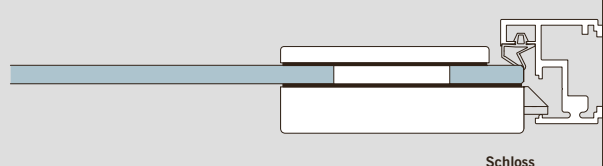

Schloss  
lock

Junior Office mit Anschraub-Rahmenteil  
Junior Office with screw-on frame pivot

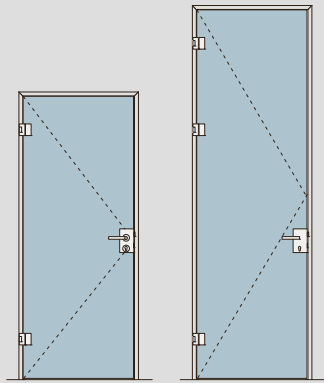

501

502

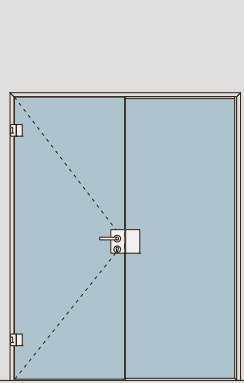

503

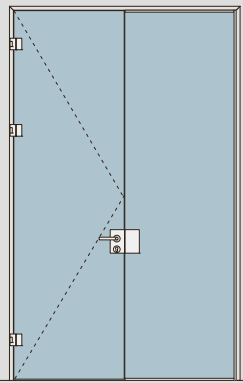

504

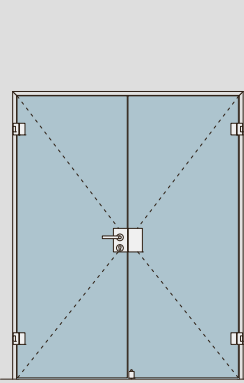

505

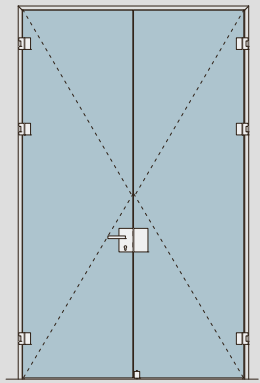

506

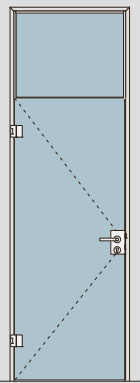

507

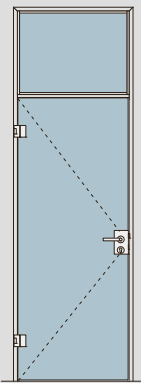

507S  
auf Anfrage  
on request

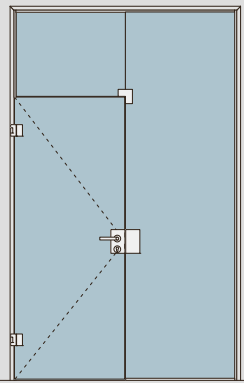

508  
auf Anfrage  
on request

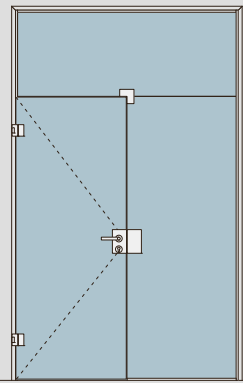

509  
auf Anfrage  
on request

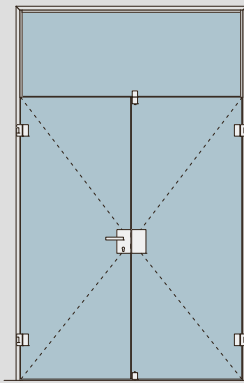

510



**ALEXA AT 50 –  
freistehende  
Anschlagtürzarge**

für Kombination mit feststehenden Glasseitenteilen und Oberlichtern. Für 8 / 10 mm Glas im Türenbereich. Glasseitenteile und Oberlichter immer vorgerichtet für 10 mm Glas.

Passend für DORMA Office (ARCOS, Junior, Classic), Studio (ARCOS, Rondo, Classic, Gala) sowie MEDIO und DORMA EA.

Max. Türgewicht 45 bis 65 kg

Wandanschluss – der an den Seitenteilen weiterführende Boden- Wand- und Deckenanschluss kann wahlweise mit AT 44 oder MR 28 Rahmenprofilen gestaltet werden.

Bitte bei Bestellung angeben!

**Standard-Oberflächen**

- LM silber EV1 (101)
- LM ähnlich Niro matt C 31 (113)

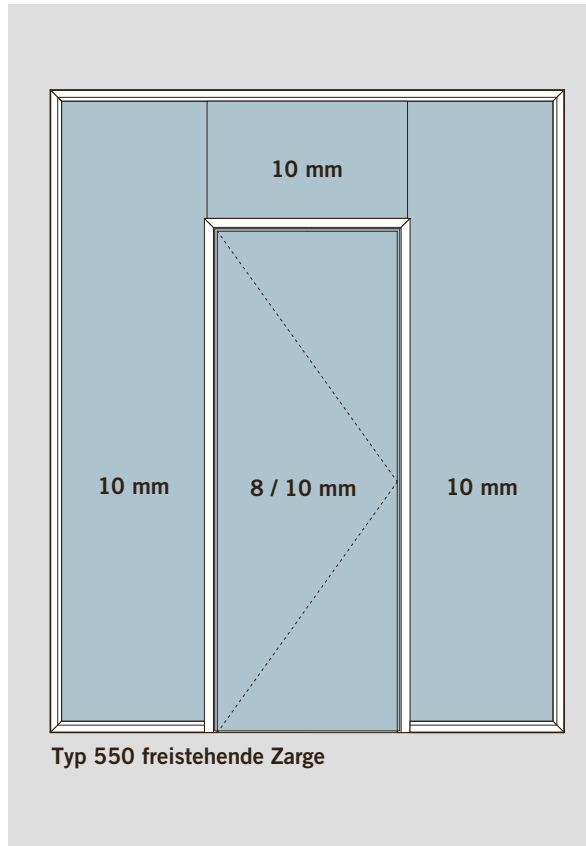
**ALEXA AT 50 –  
free standing  
connecting door frame**

for combination with fixed glass sidelights and overpanels. For 8 / 10 mm glass in the door area.

Glass sidelights and overpanels always prepared for 10 mm glass.

Suitable for DORMA Office (ARCOS, Junior, Classic), Studio (ARCOS, Rondo, Classic, Gala) as well as for MEDIO and DORMA EA.

Max. door weight 45 up to 65 kg

Wall connection – Both AT 44 and MR 28 frame profiles can be used for the floor, wall and ceiling joints extending across the sidelights.

Please indicate when placing an order!

**Standard finishes**

- aluminium silver EV1 (101)
- aluminium similar satin stainless steel C 31 (113)

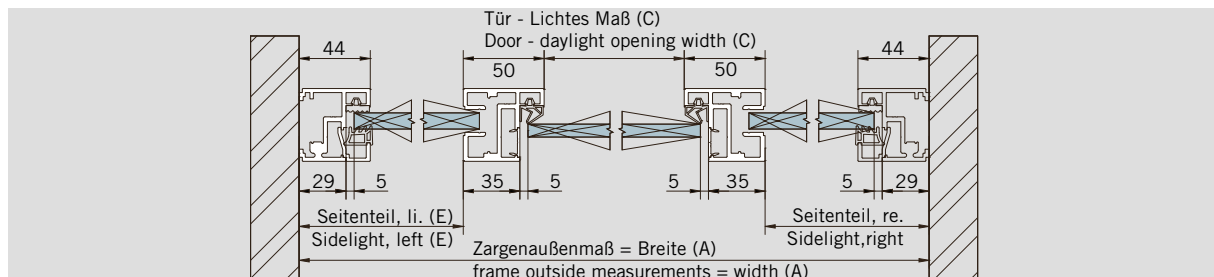

Anschlussrahmen mit AT 44 / Connecting frame with AT 44

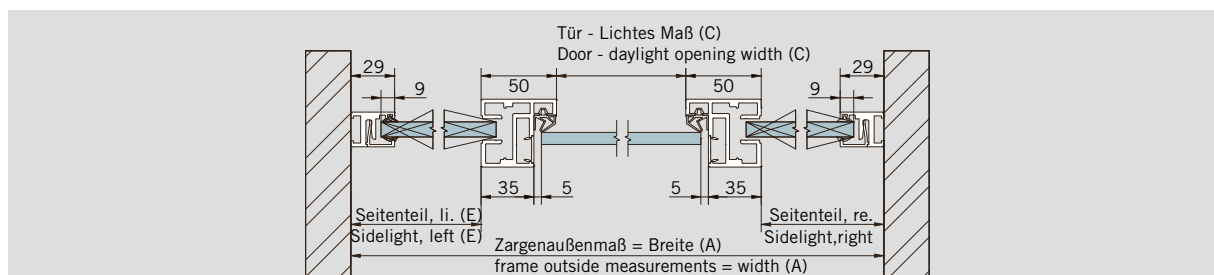

Anschlussrahmen mit MR 28 / Connecting frame with MR 28

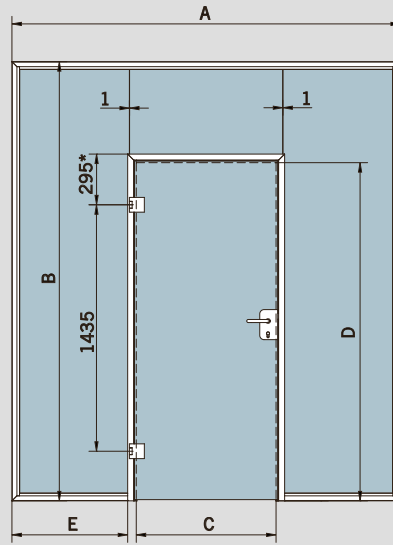

\* Angabe für Office Bänder  
bei Verwendung von Studio = 254 mm  
\* Indication for Office hinges  
when using Studio = 254 mm

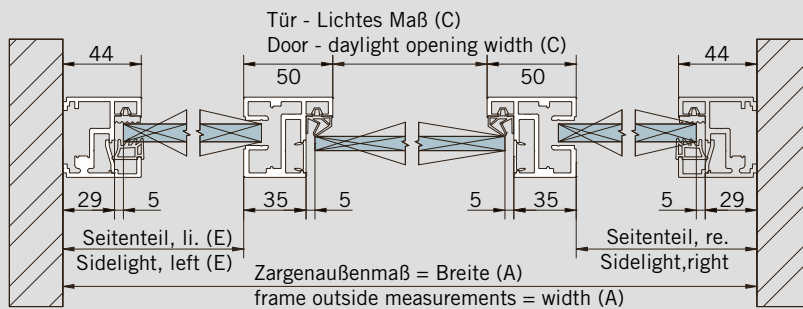
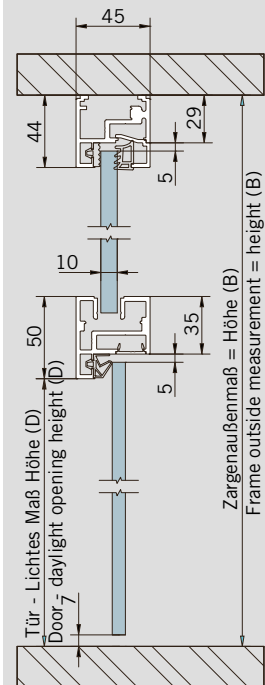
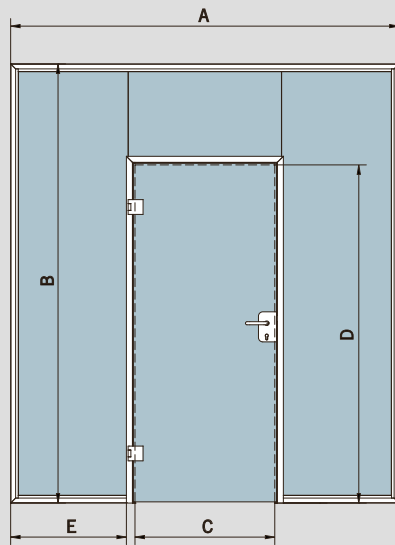

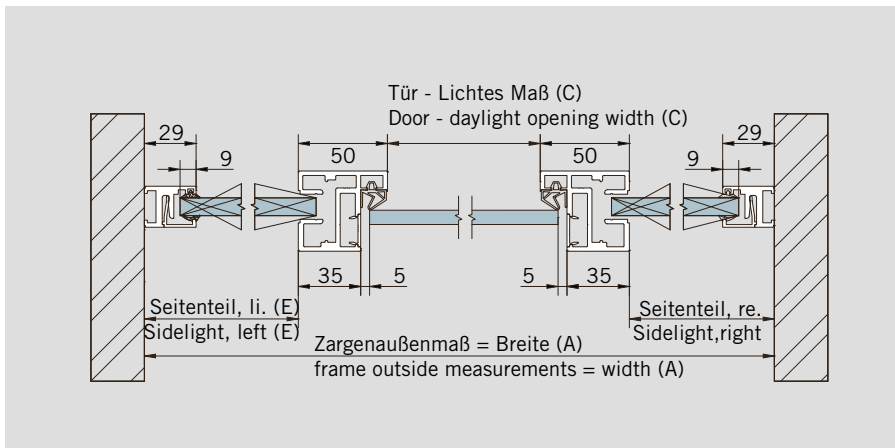
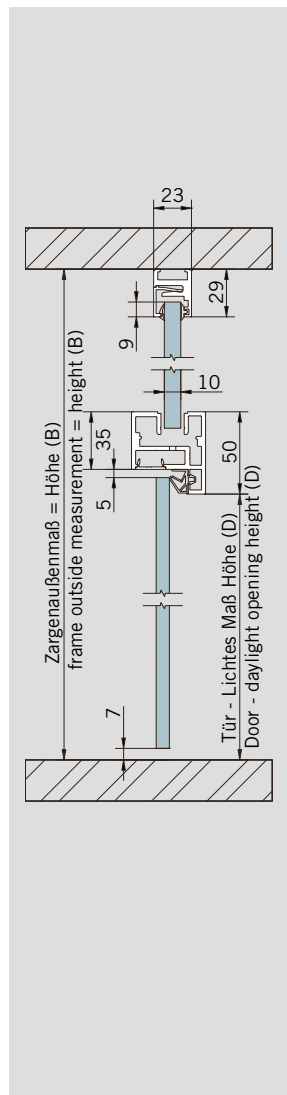
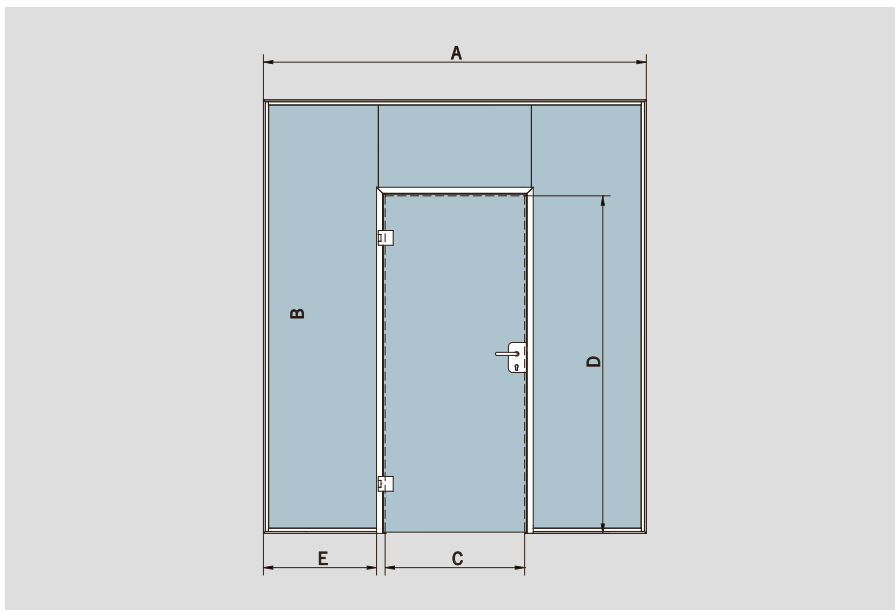
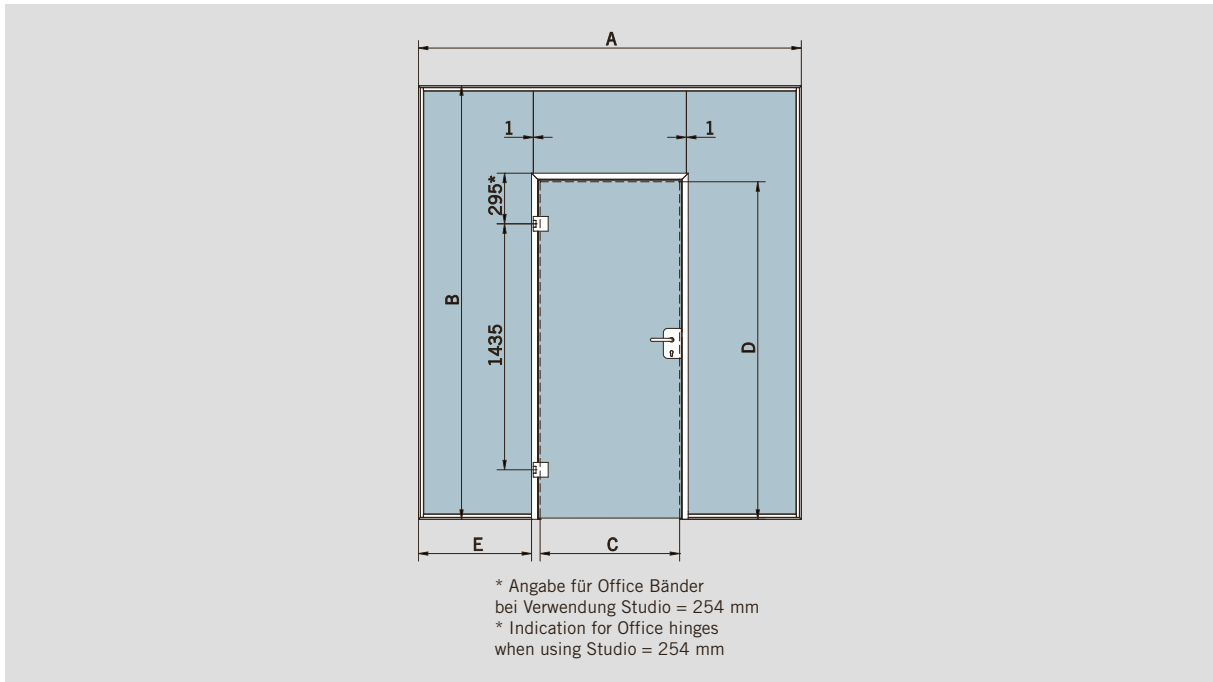

**Wandanschluss-Rahmensystem MR 28**

bestehend aus einem Rahmenprofil (rastergebohrt), einem Spannprofil und zwei Anschlaggummiprofilen (PVC, transparent). Die zierliche und elegante Rahmenlösung eignet sich sowohl für den Innen- als auch für den Außenbereich und zeichnet sich durch eine sehr einfache Montage aus. Die Ansichtsbreite beträgt lediglich 28 mm. In Kombination mit AT 50 wird immer eine Glasstärke von 10 mm eingesetzt. Über die Profile erfolgt keine Lastabtragung. Die Demontage und der Wiedereinbau sind problemlos möglich.

Anwendung:

z. B. umlaufender Rahmen für Ganzglas-Anlagen mit Befestigung zur Wand und zur Decke.

**Wall connecting frame system MR 28**

comprising a frame profile (series-drilled), a clamping profile and two contact rubber extrusions (PVC, transparent).

These decorative and elegant frame solutions are suitable for both indoor and outdoor applications and are characterised by their remarkably easy installation.

The viewface width is just 28 mm. In combination with AT 50 only suitable for glass thickness of 10 mm. No load transfer by the profiles. Can be readily removed and re-installed else-where.

Applications:

e.g. surrounding frame for toughened glass systems for fixing to walls and ceilings

**Grundprofil**

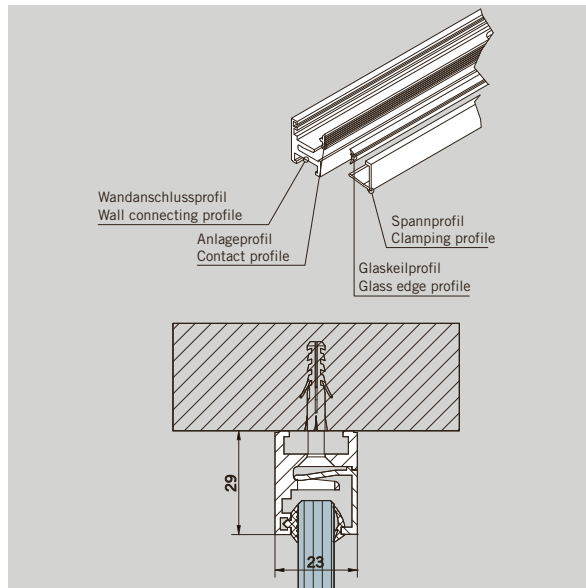

**Base profile**

**MR 28**  
in 6000 mm Lagerlängen,  
ohne PVC-Profilie  
**Art.-Nr. 07.241**

Gewicht in kg/m:  
LM 0,802

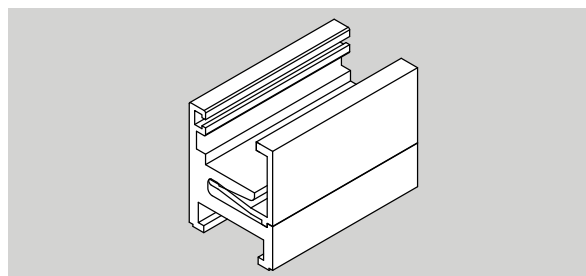

**MR 28**  
in 6000 mm stock length,  
without PVC profile  
**Art. No. 07.241**

Weight in kg/m:  
aluminium 0,802

**MR 28**  
in Fixlängen  
**Art.-Nr. 07.251**

Gewicht in kg/m:  
LM 0,802

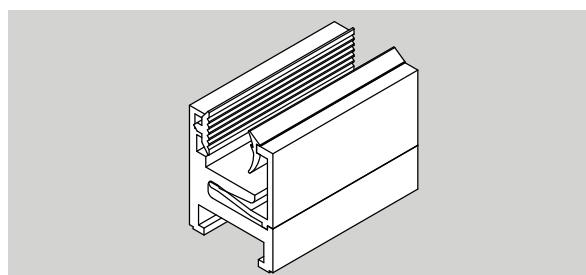

**MR 28**  
in fixed length  
**Art. No. 07.251**

Weight in kg/m:  
aluminium 0,802

**Stirnabdeckung MR 22**  
**Art.-Nr. 07.245**

Gewicht in kg/Stck:  
LM 0,002

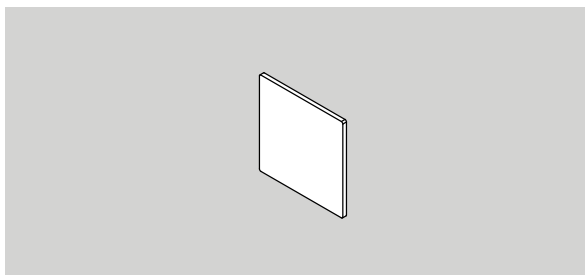
**End mounted plate MR 22**  
**Art. No. 07.245**

Weight in kg/pc:  
aluminium 0,002

**Stirnabdeckung MR 28**  
**Art.-Nr. 07.246**

Gewicht in kg/Stck:  
LM 0,002

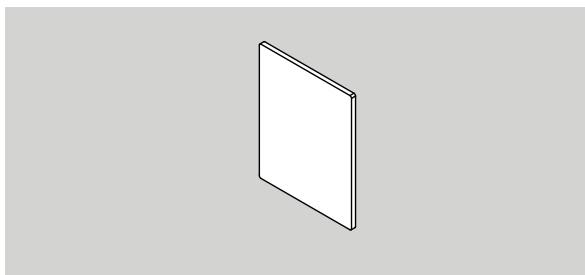
**End mounted plate MR 28**  
**Art. No. 07.246**

Weight in kg/pc:  
aluminium 0,002

**Anlageprofil**  
 in 50 m Lagerlängen (Rolle)  
**Art.-Nr. 07.255**

Gewicht in kg/m:  
PVC 0,023

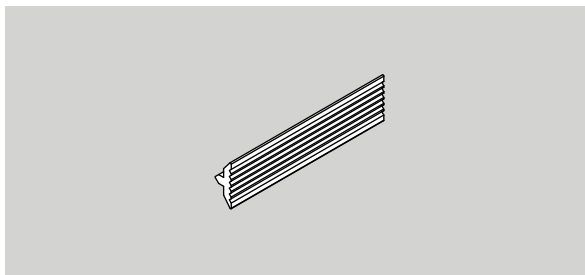
**Contact profile**  
 in 50 m stock length (roll)  
**Art. No. 07.255**

Weight in kg/m:  
PVC 0,023

**Glaskeilprofil**  
 2 mm,  
 für 10 mm Glasdicke,  
 in 50 m Lagerlängen (Rolle)  
**Art.-Nr. 07.253**

Gewicht in kg/m:  
PVC 0,016

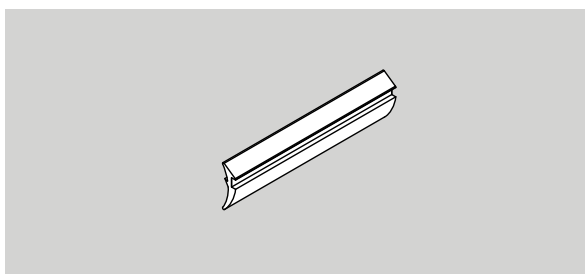

**Glass edge profile**  
 2 mm,  
 für 10 mm glass thickness,  
 in 50 m stock length (roll)  
**Art. No. 07.253**

Weight in kg/m:  
PVC 0,016

**Eckverbinder MR 28**  
**Art.-Nr. 07.247**

Gewicht in kg/Stck:  
LM 0,0021

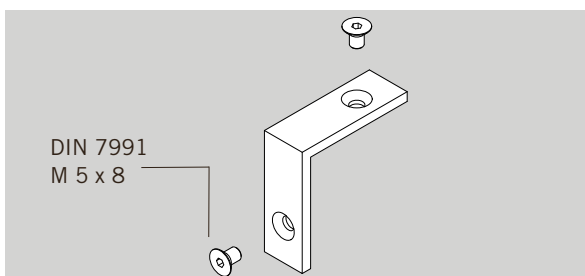
2 Schrauben DIN 7991  
 M 5 x 8 im Lieferumfang  
 enthalten

**Corner connection MR 28**  
**Art. No. 07.247**

Weight in kg/pc:  
aluminium 0,0021

2 screws DIN 7991  
 M 5 x 8 are included in  
 delivery

**ALEXA PT 35 –  
Pendeltürzarge für  
10 mm Glas**

Mit verdeckter Befestigung für ein- und doppel­flügelige Türanlagen, mit Oberlicht und/oder festen Seitenteilen.

Passend für DORMA Universal-Eckbeschläge, ARCOS Universal-Eckbeschläge und entsprechende Schlösser und Griffe.

Feststehende Teile werden mit Silicon versiegelt.

**Max. Türgewicht** 80 kg

**Standard-Oberflächen**

- LM silber EV1 (101)
- LM ähnlich Niro matt C 31 (113)

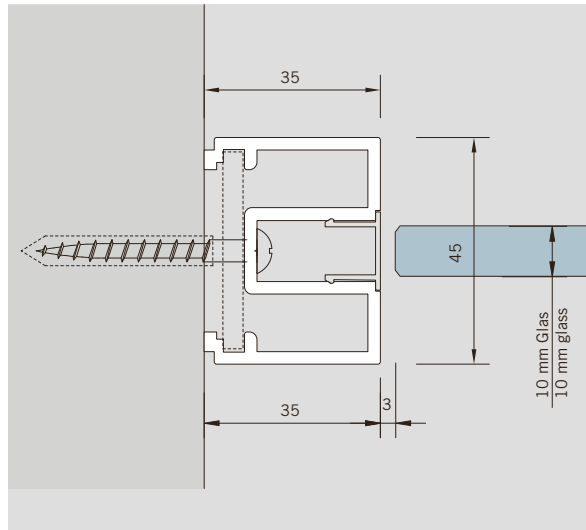
**ALEXA PT 35 –  
double action door frame  
for 10 mm glass**

With concealed fixing for single and double action door assemblies, with over-panel and/or fixed sidelights.

Suitable for DORMA Universal patch fittings, ARCOS Universal patch fittings and appropriate locks and handles.

Fixed parts will be sealed with silicon.

**Max. door weight** 80 kg

**Standard finishes**

- aluminium silver EV1 (101)
- aluminium similar satin stainless steel C 31 (113)

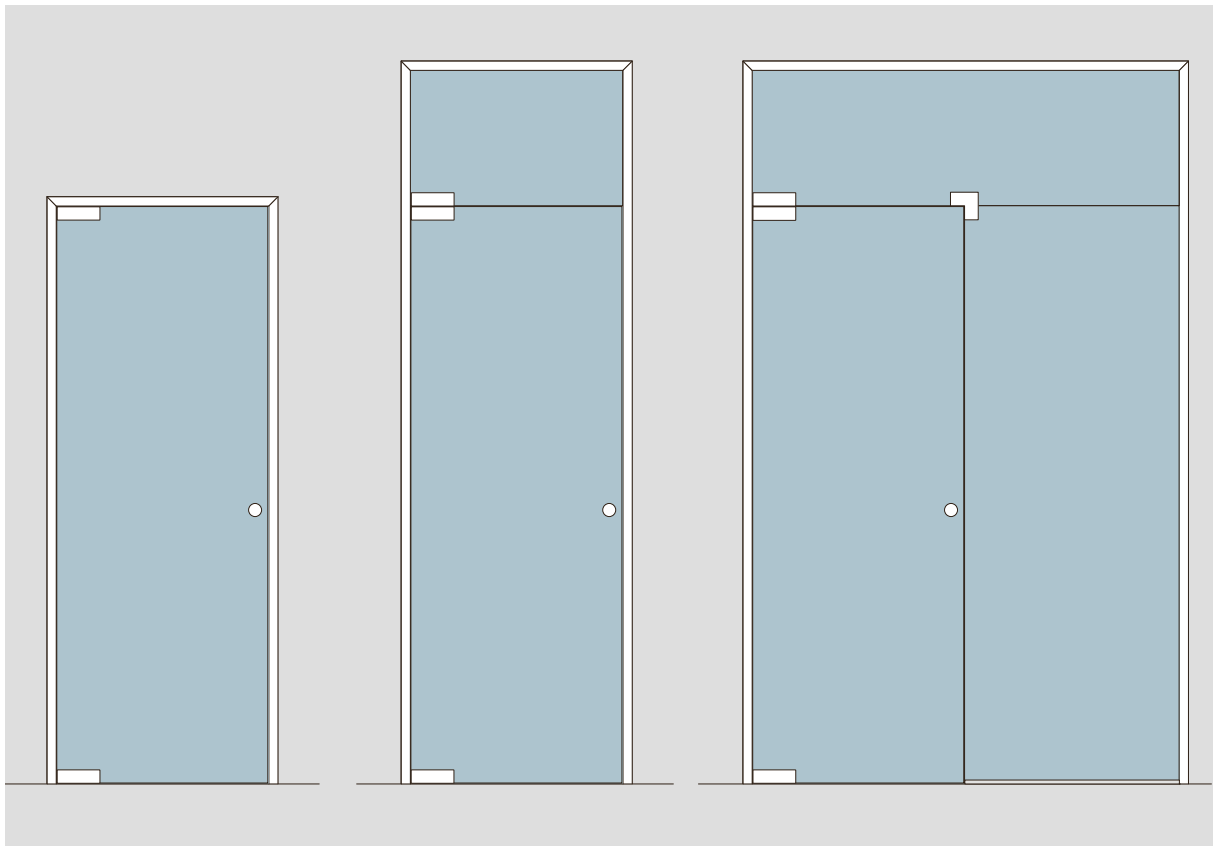

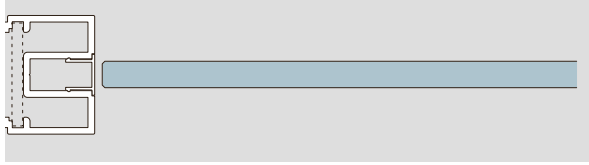
**Die Profile / Profiles**

ALEXA PT 35 Zargenprofil mit Clipsprofil  
 ALEXA PT 35 frame profile with cover clip profile

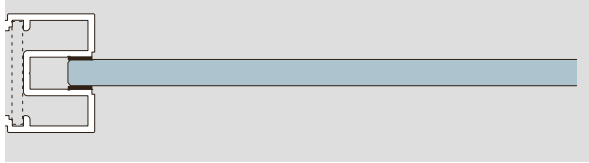

ALEXA PT 35 Zargenprofil mit Glaseinstand  
 ALEXA PT 35 frame profile with glass penetration

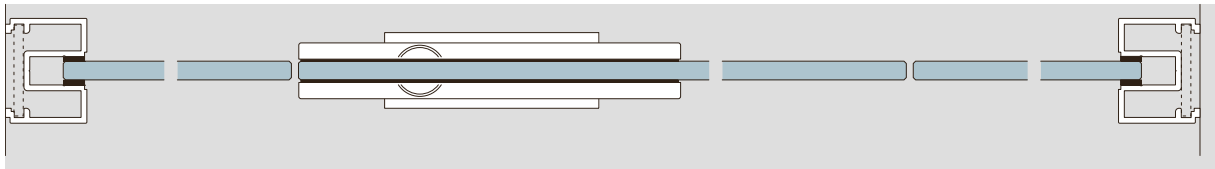
**Die Beschlagvarianten-Beispiele / fitting variants – examples**

ALEXA PT 35 mit DORMA Universal Eckbeschlägen, Bodendrehlager  
 ALEXA PT 35 with DORMA Universal patch fitting, floor pivot bearing

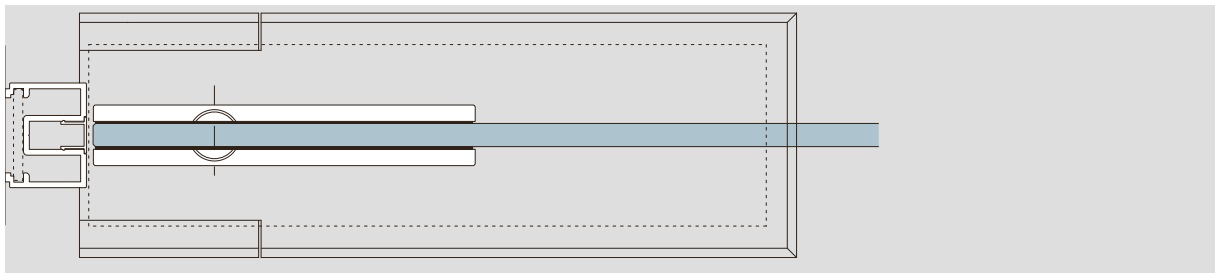

ALEXA PT 35 mit DORMA Universal Eckbeschlägen, Bodentürschließer BTS 75 V  
 ALEXA PT 35 with DORMA Universal patch fitting, floor closer BTS 75 V

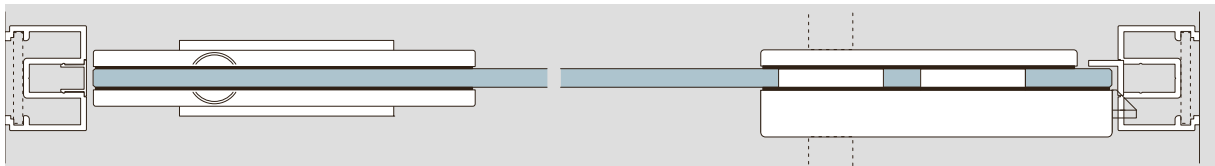

ALEXA PT 35 mit DORMA Universal Eckbeschlägen,  
 Bodendrehlager  
 ALEXA PT 35 with DORMA Universal patch fitting,  
 floor pivot bearing

Schloss, Studio Rondo / Classic  
 lock, Studio Rondo / Classic

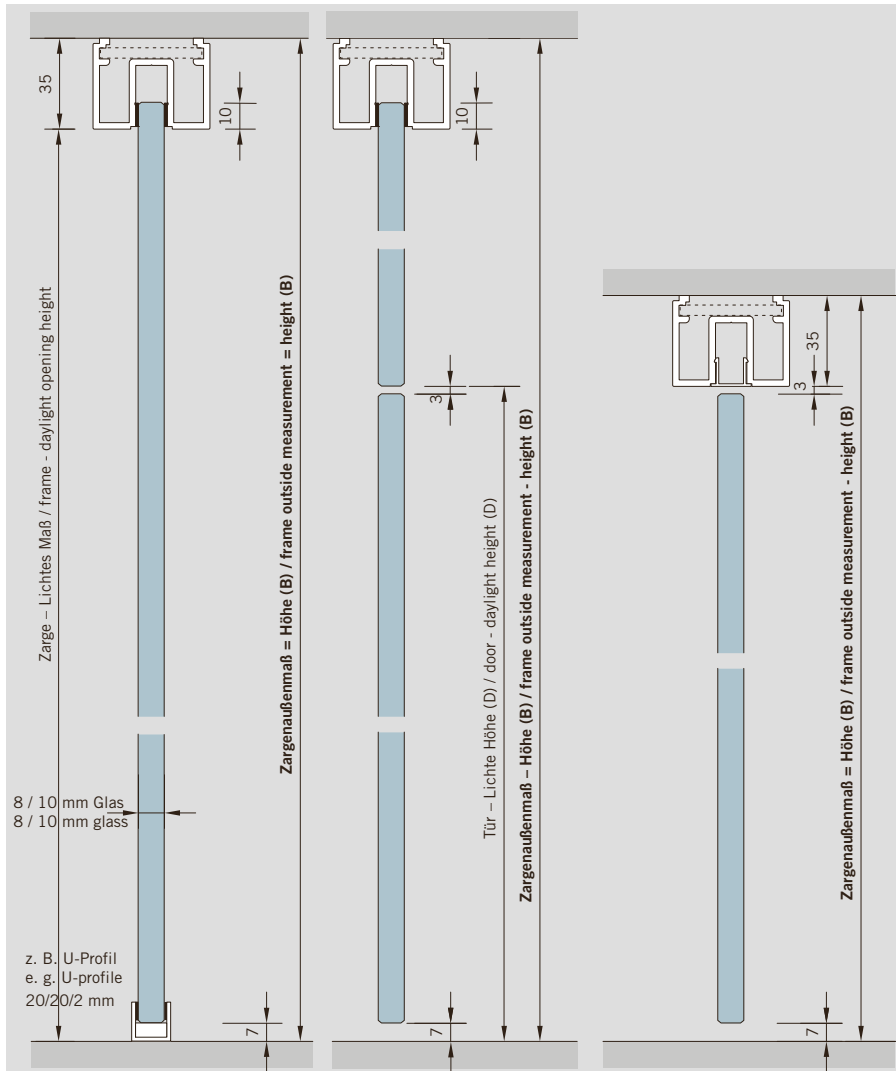

Schnitt / Festverglasung  
sectional cut / fixed glazing

Schnitt / Tür mit Oberlicht  
sectional cut / door with  
overpanel

Schnitt / Tür  
sectional cut / door

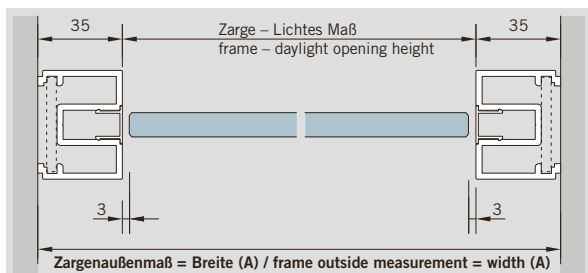

Grundriss / Tür / plan / door

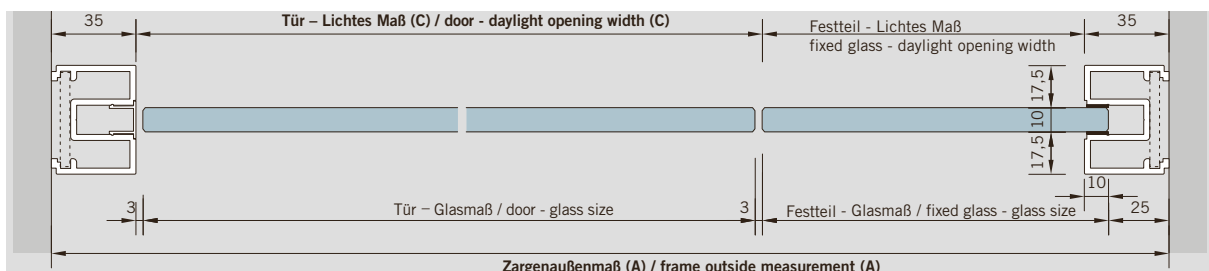

Grundriss / Tür mit Festverglasung / plan / door with fixed glazing



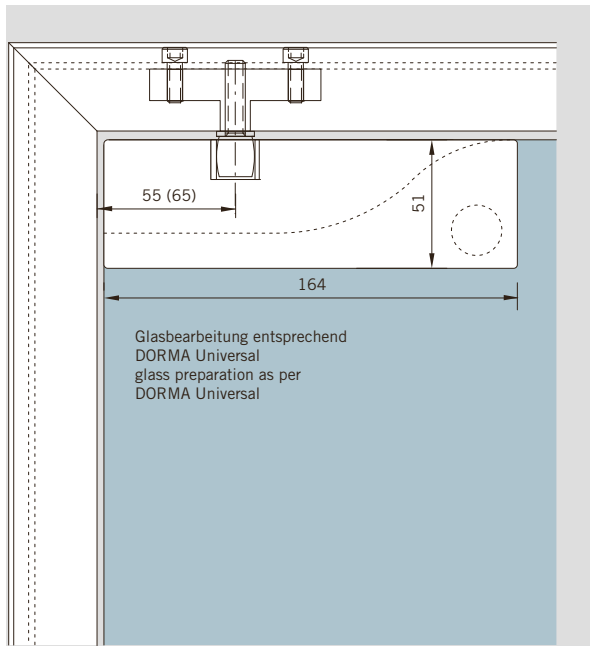

Ansicht DORMA Universal Eckbeschlag oben  
view DORMA Universal top patch fitting

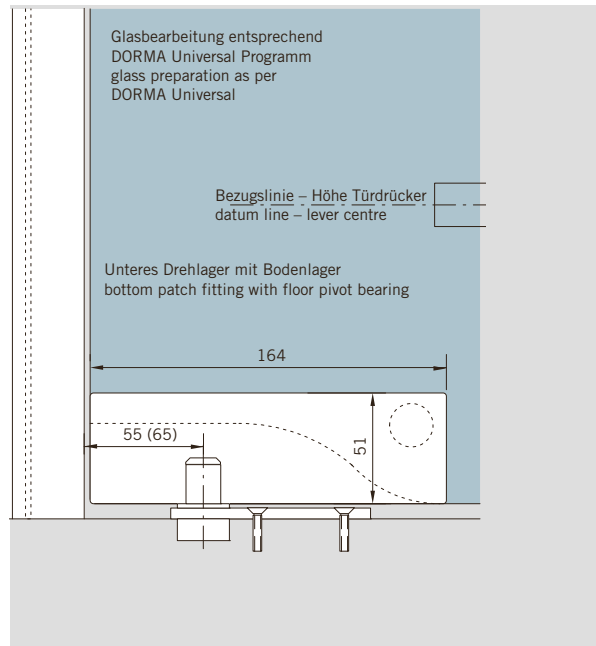

DORMA Universal Eckbeschlag unten, Ansicht  
view DORMA Universal bottom patch fitting

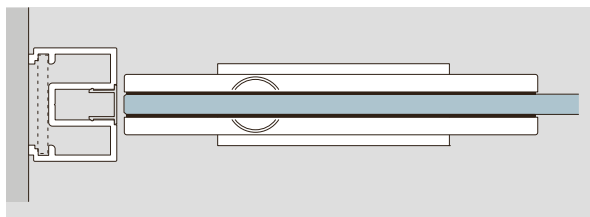

DORMA Universal Eckbeschlag, Grundriss  
plan DORMA Universal patch fitting

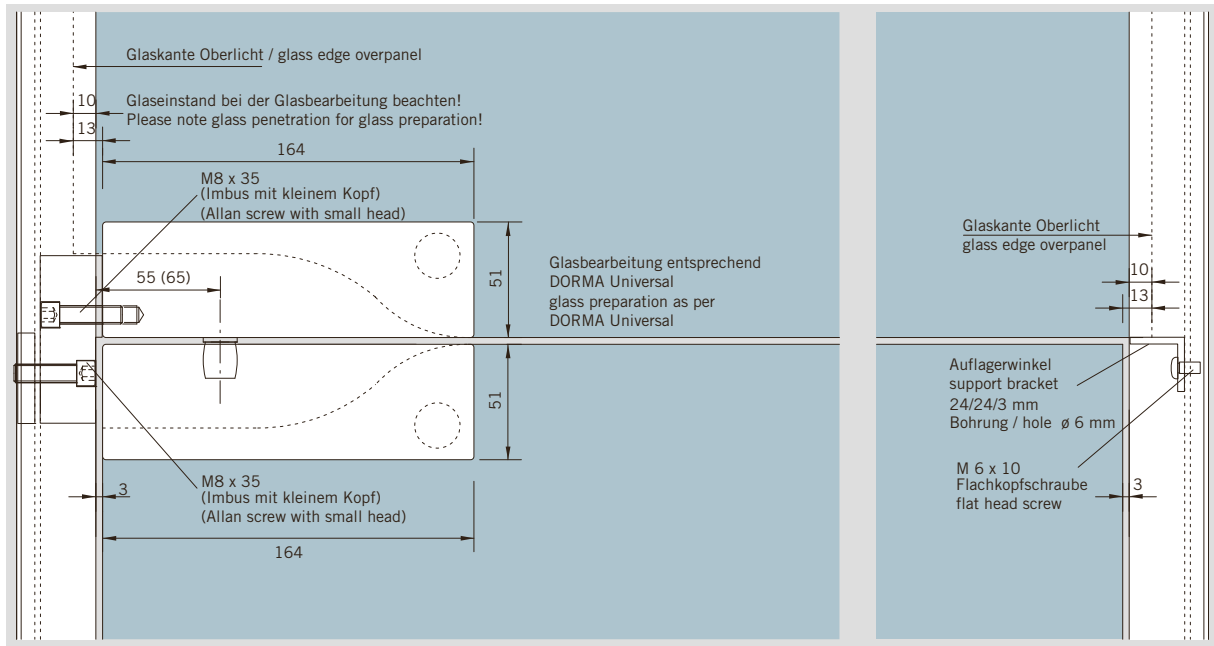

Ansicht DORMA Universal Eckbeschlag  
view DORMA Universal patch fitting

Ansicht Auflager – Oberlicht  
view overpanel support

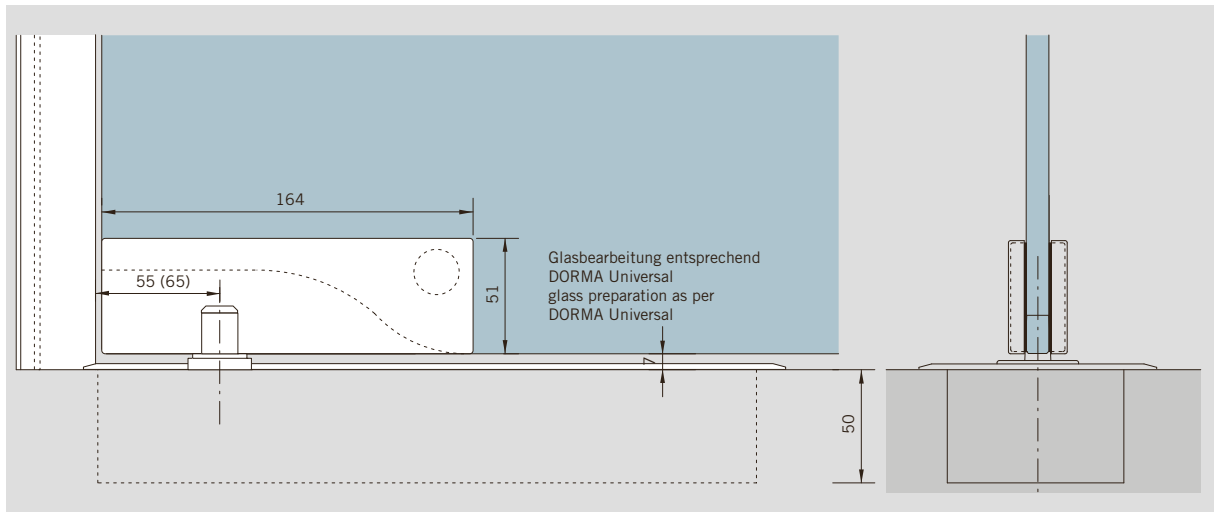

Ansicht DORMA Universal Eckbeschlag, Bodentürschließer  
view DORMA Universal patch fitting, floor spring

Schnitt – Bodentürschließer  
sectional cut – floor spring

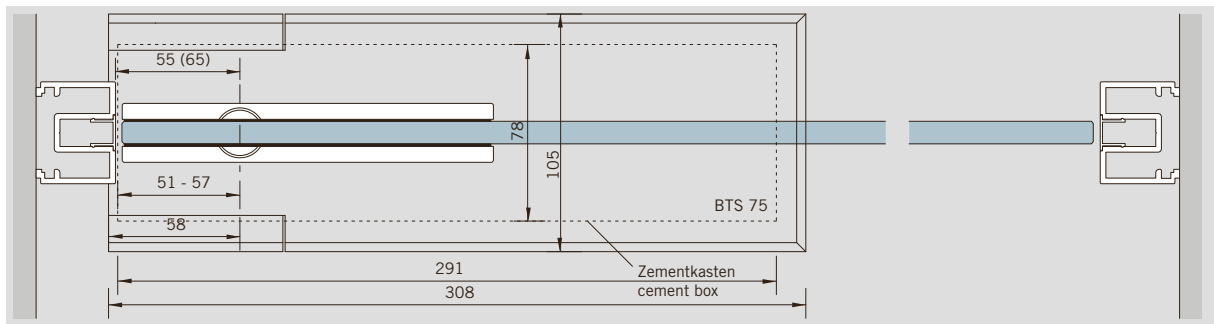

Grundriss, Pendeltür mit DORMA BTS 75 V / plan, double acting door with DORMA BTS 75 V

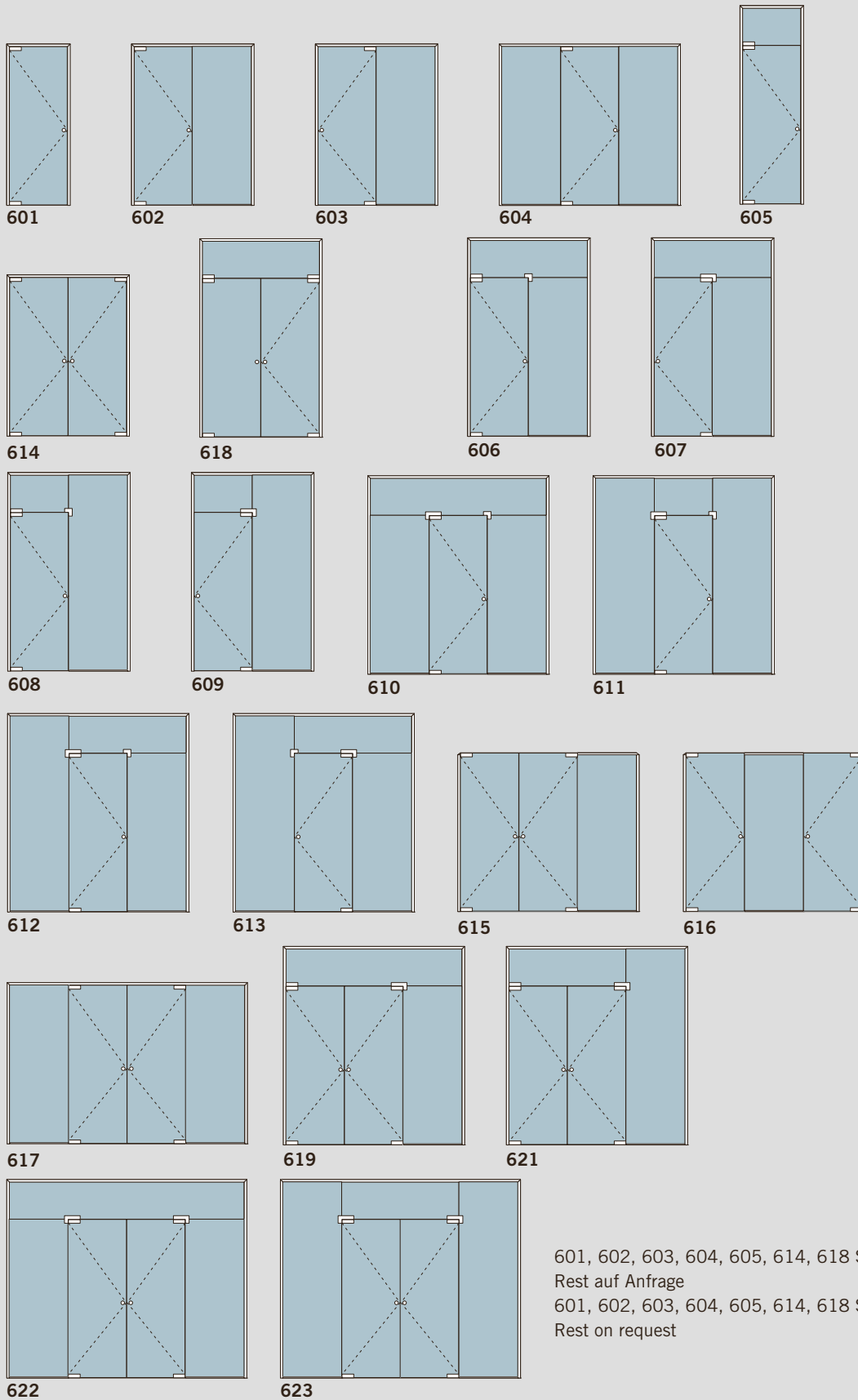



DORMA-Glas GmbH  
Postfach 32 68  
D-32076 Bad Salzflun  
Max-Planck-Straße 33 - 45  
D-32107 Bad Salzflun  
Tel. +49 5222 924-0  
Fax +49 5222 21009  
[www.dorma-glas.com](http://www.dorma-glas.com)